

 hachette
PARTWORKS LTD

U 96

U-BOAT

Pack 6

Kits 21-24



BUILD THE ICONIC WORLD WAR II U-BOAT

U 96

U-BOAT

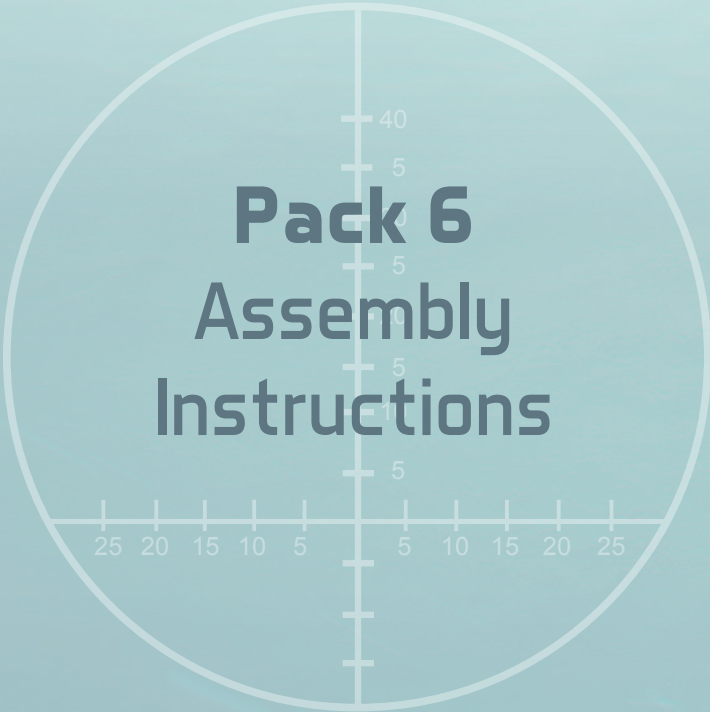

Pack 6

Assembly Instructions

Kit 21: Forward crew quarters

Kit 22: Commander's quarters

Kit 23: Radio room & listening room

Kit 24: Forward PCB



Hachette Partworks Ltd
4th Floor, Jordan House,
47 Brunswick Place, London, N1 6EB
www.U96-collection.com

© 2023/2024 Hachette Partworks Ltd.
ALL RIGHTS RESERVED
Not suitable for children under 14.

WARNING: All parts belong to a kit.
Collectors' item for adults. Not suitable for
children under 14. Some parts may have
sharp edges, please handle them with care.

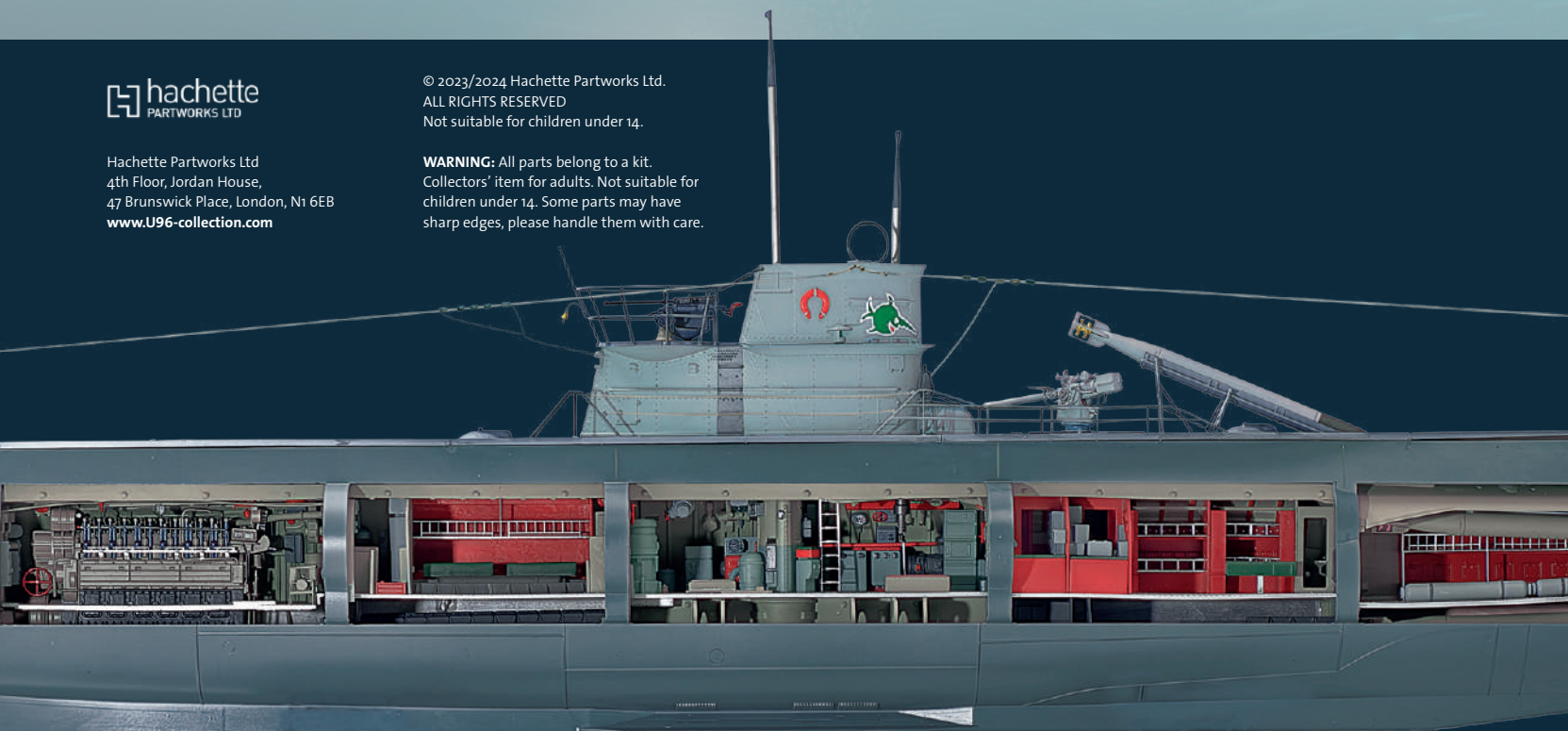

Kit 21: Forward crew quarters

In this kit you will begin the assembly of the forward crew quarters. Bunks are assembled and then installed, then room dividers are fitted with lockers and bunk rails before being added to the assembly.

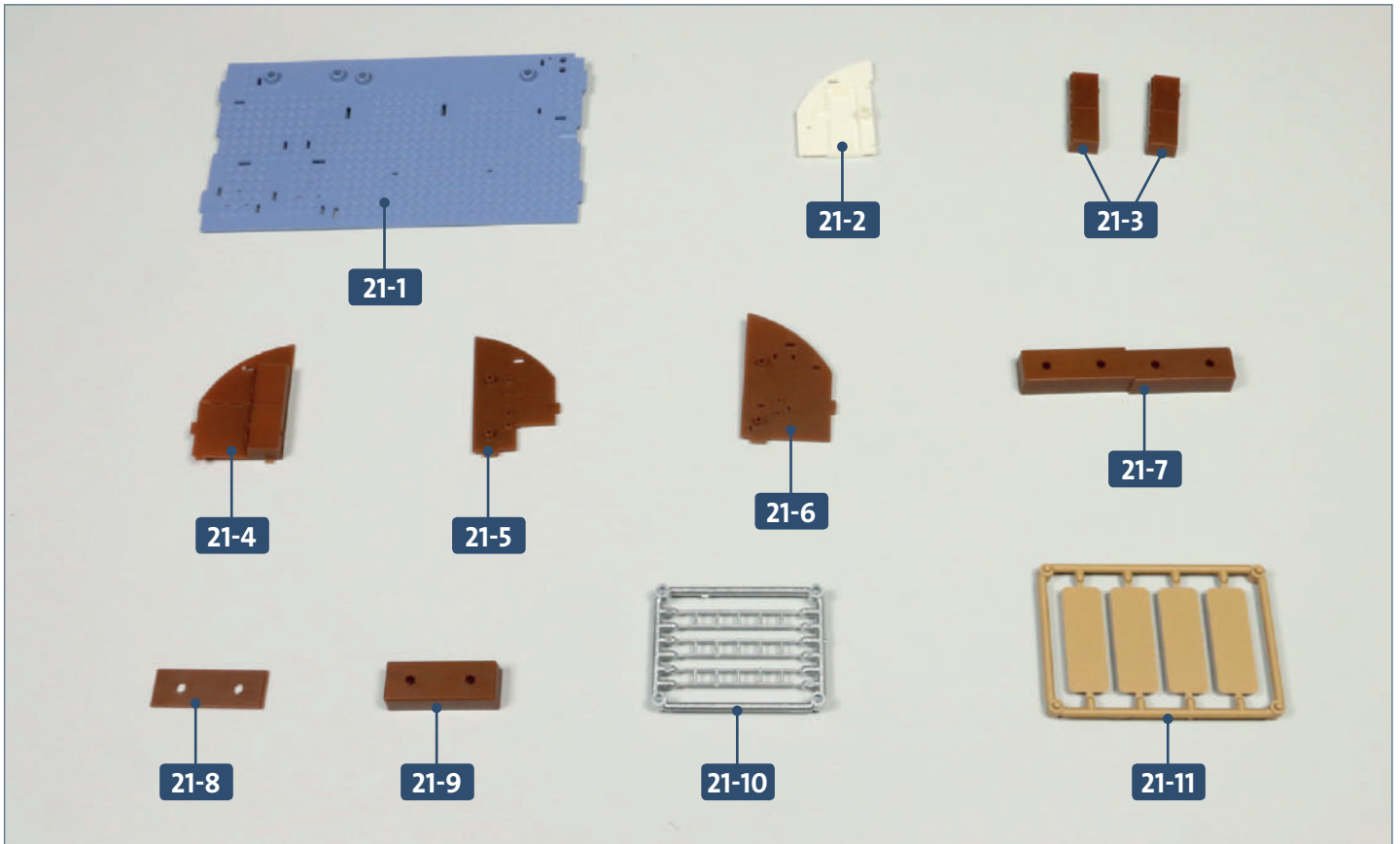

Parts reference list	
Part no.	Name
21-1	Forward crew quarters deck
21-2	Toilet bulkhead
21-3	Lockers
21-4	Room divider
21-5	Room divider
21-6	Room divider
21-7	Bunk frame
21-8	Bunk spacer
21-9	Bunk frame
21-10	Bunk rails
21-11	Four bunks

Kit 21: Forward crew quarters

STAGE 1 → Forward crew quarters

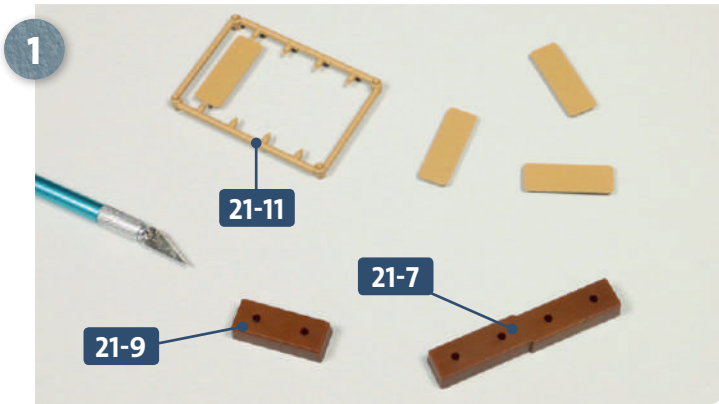

Take both bunk frame parts, **21-7** and **21-9**. Separate three of the bunks from frame **21-11** as shown above.

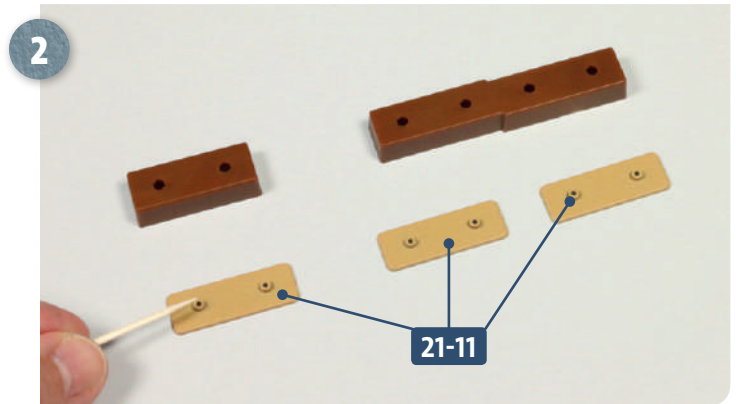

Turn the three bunks **21-11** so that their undersides are facing upwards and apply a little glue to each of the two pegs, as shown in the photo.

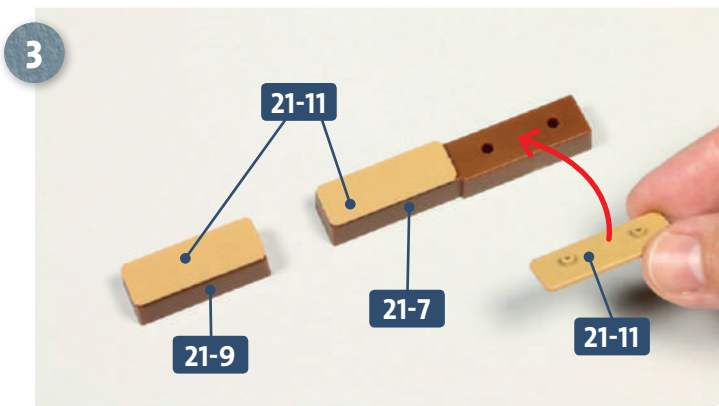

Fit the first bunk **21-11** onto bunk frame **21-9**. The two remaining bunks **21-11** are fitted onto bunk frame **21-7**, as shown above.

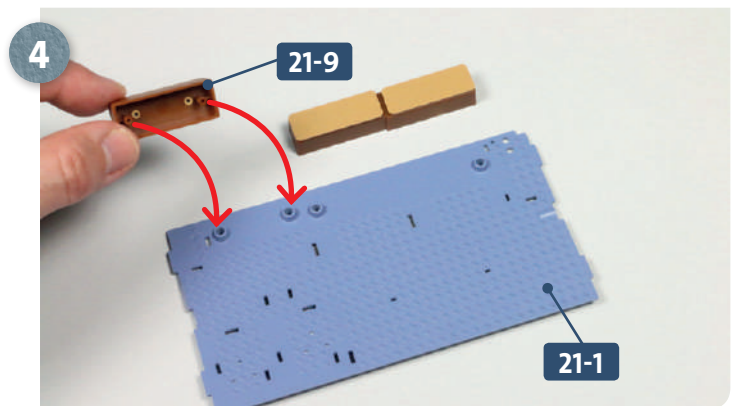

Place the forward bunk room deck **21-1** on your work surface as shown above. Apply glue to the two pegs on the underside of the bunk frame **21-9** and attach to the bunk room deck in the position indicated by the arrows, above.

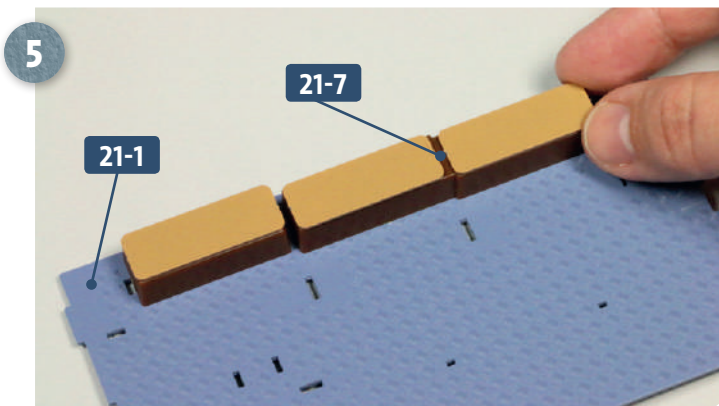

Attach the double bunk frame **21-7** to the deck **21-1** in the same way, as shown.

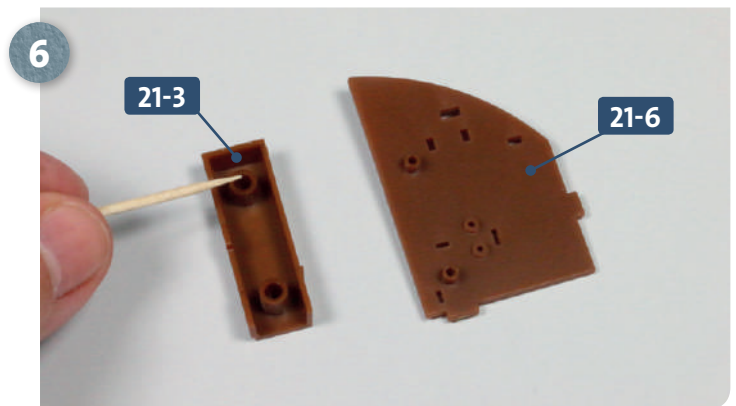

Take room divider **21-6**. Place one of the lockers **21-3** next to it, the inside facing up. Add some glue to the two raised sockets inside the locker.

Kit 21: Forward crew quarters

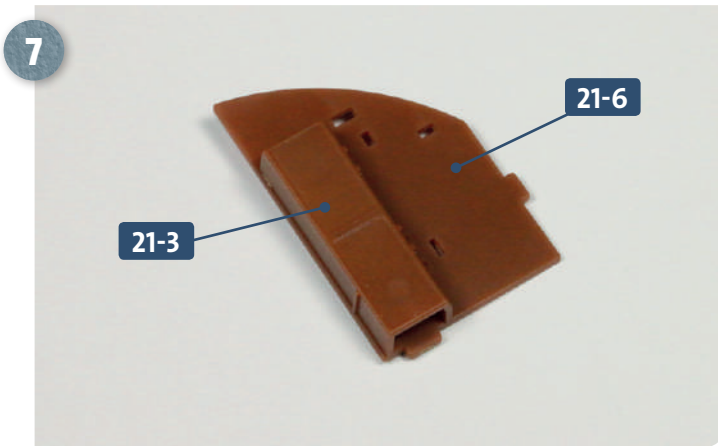

Glue locker **21-3** to the room divider **21-6**, as shown in the photo.

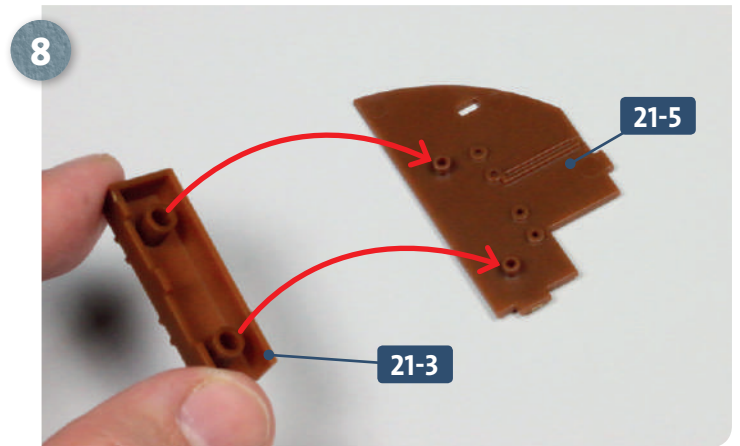

Repeat the process with room divider **21-5** and the second locker **21-3**: add some glue to the raised sockets and join the two parts together as shown.

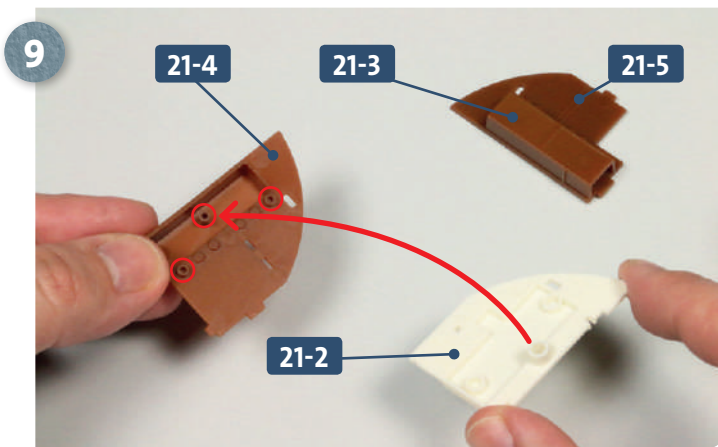

The photo shows the locker **21-3** attached to room divider **21-5**. Now take the toilet bulkhead **21-2** and room divider **21-4**: apply some glue to their raised sockets (circled) and join the parts as shown by the arrow.

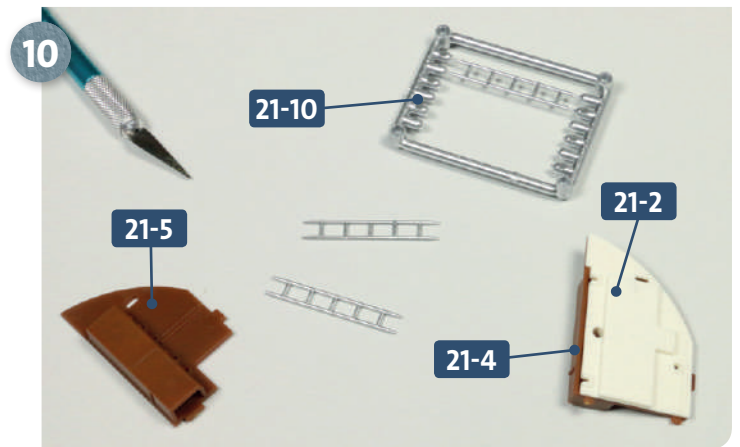

Next, take room divider **21-5** and detach two of the bunk rails from frame **21-10**, as shown. Take care not to accidentally remove the pins at the end of the rails.

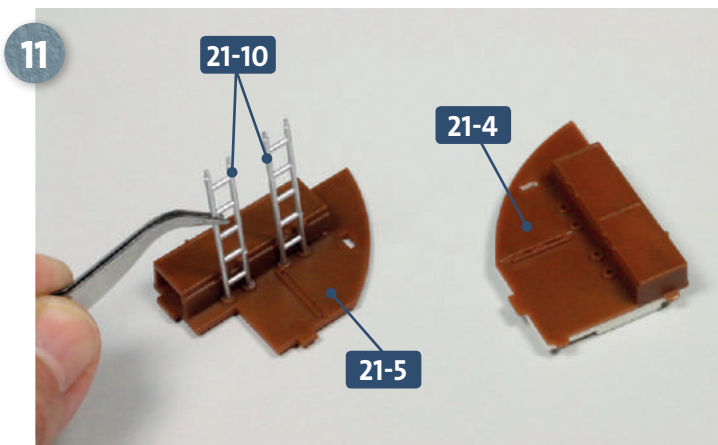

Glue the ends of the two bunk rails **21-10** into the recesses in the room divider **21-5**, as shown above. Have ready the room divider assembly **21-4**.

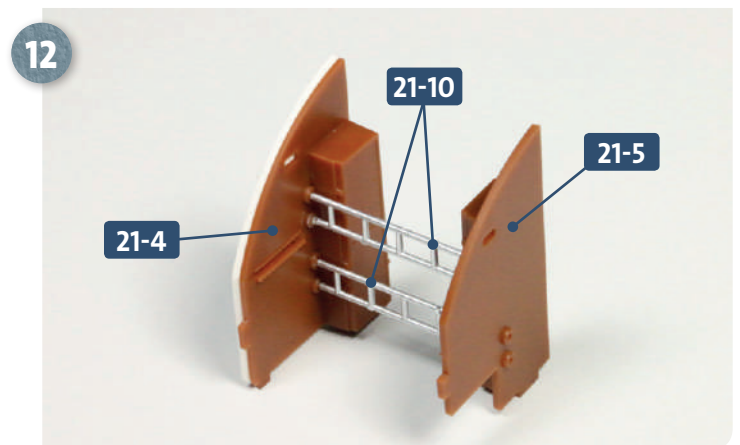

The other ends of the two bunk rails **21-10** are then glued into the four holes in room divider **21-4**.

Kit 21: Forward crew quarters

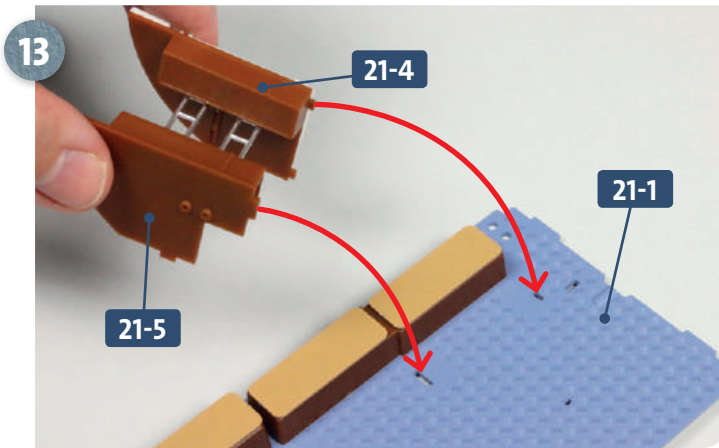

Apply some glue to the pegs at the bottom of the room dividers **21-4** and **21-5** and insert them into the corresponding slots in the bunk room deck **21-1**, indicated by the arrows.

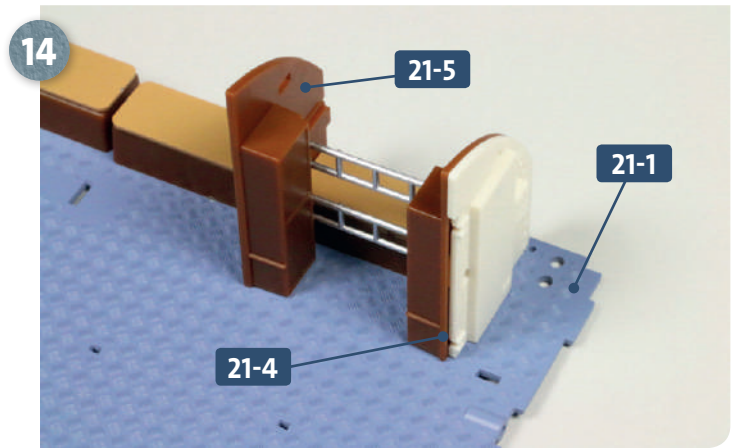

The photograph shows the completed bunk room deck assembly with added room dividers. Make sure that the bottom edges of the dividers **21-4** and **21-5** are in full contact with the deck.

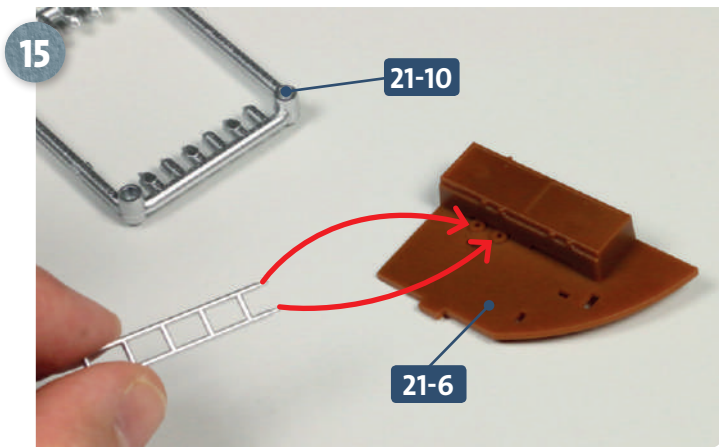

Take the room divider **21-6** and detach the remaining bunk rail from its frame **21-10**. Apply some glue to the ends of the rail and insert these into the corresponding holes in the room divider as indicated by the arrows, above.

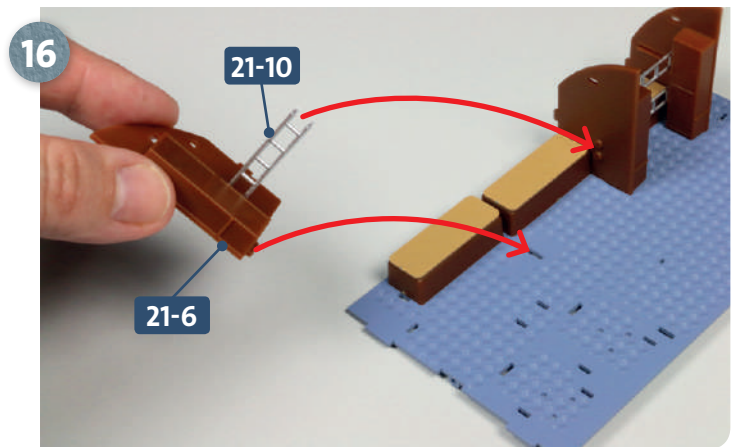

Apply some glue to the lower edges of the room divider **21-6** and to the free ends of the bunk rail **21-10** and attach to the bunk room deck assembly, as shown above.

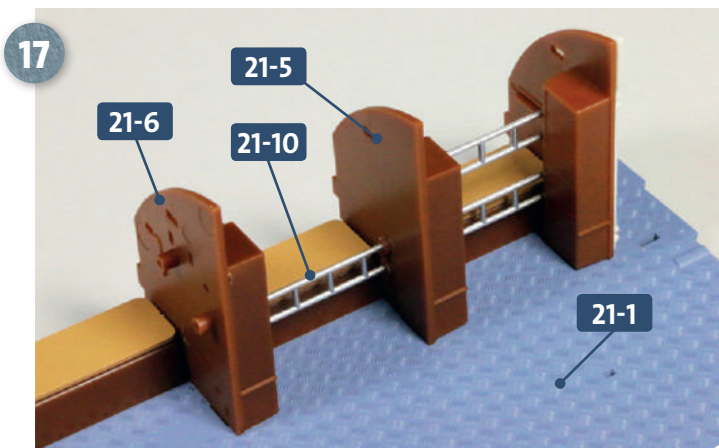

The photo shows the room divider **21-6** attached to the deck **21-1**. The free ends of the bunk rail **21-10** fit into the corresponding holes in the next divider **21-5**.

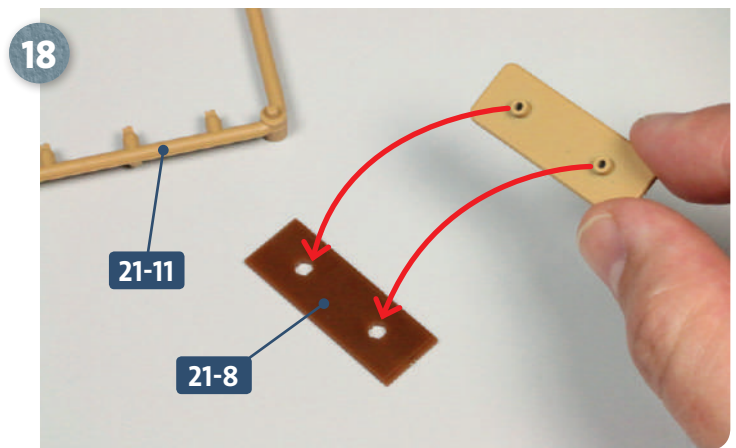

Take the bunk spacer **21-8** and detach the remaining bunk from frame **21-11**. Apply some glue to the pegs underneath the bunk and fit into the spacer, as shown.

Kit 21: Forward crew quarters

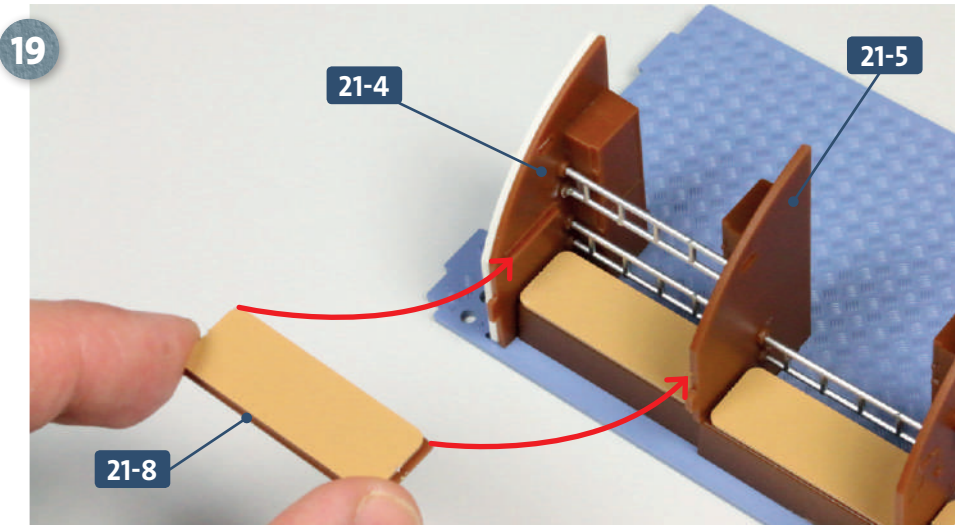

Add some glue to the channels on the two room dividers **21-4** and **21-5** and insert the bunk spacer **21-8** between the two, as shown left.

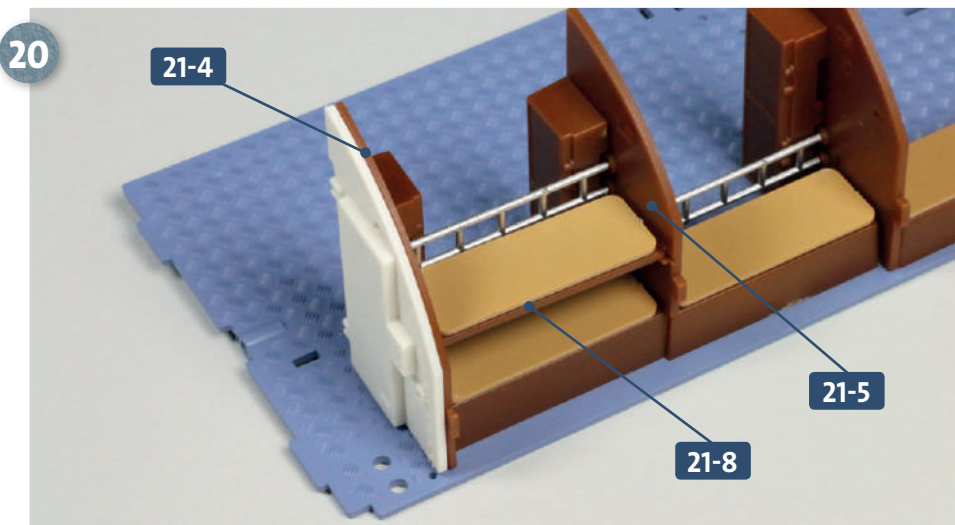

The photo shows the single bunk **21-8** fitted in position between the two room dividers, **21-4** and **21-5**.

COMPLETED WORK

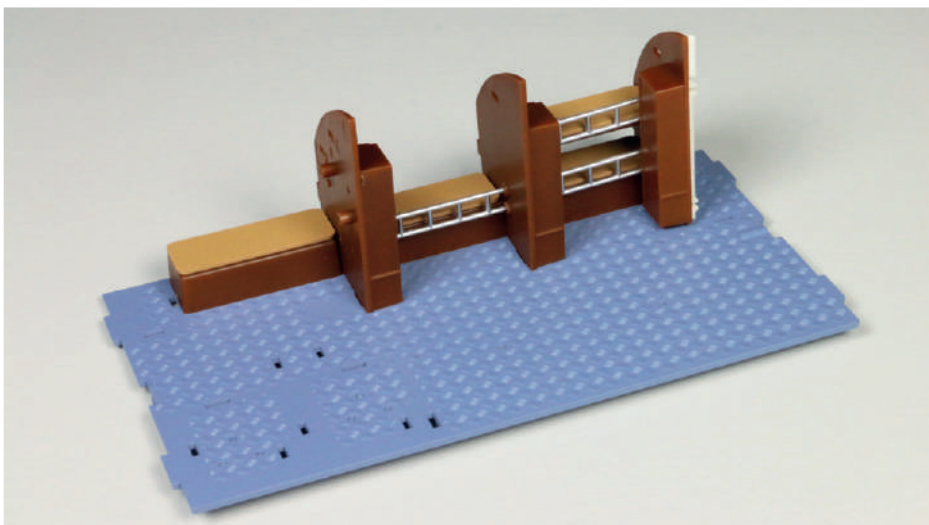

The initial forward bunk room assembly, complete with bunkers and lockers.

Kit 22: Commander's quarters

A bunk area for the commander is added and equipped with electronics, and the crew quarters receive a toilet door and another bulkhead panel.

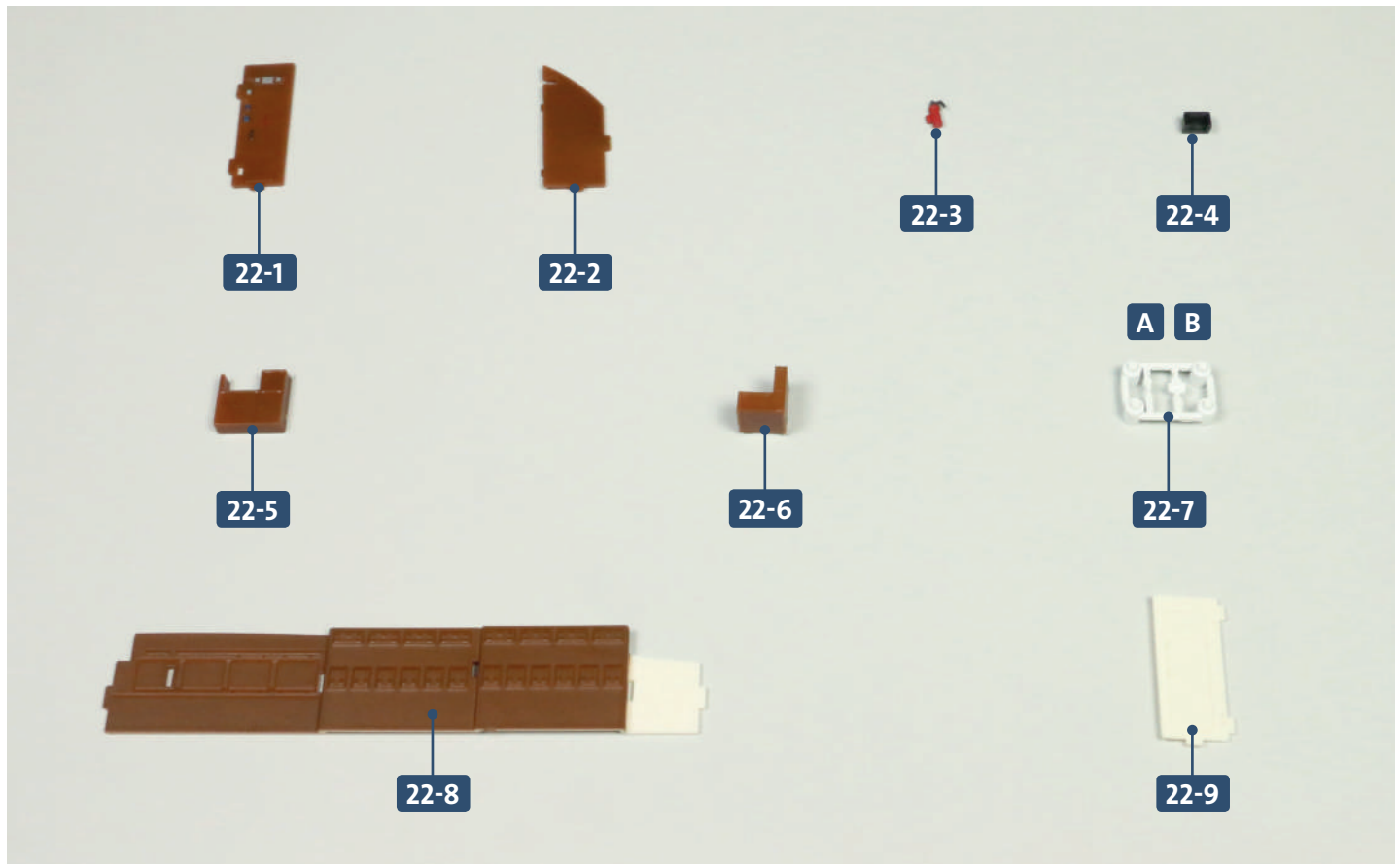

Parts reference list	
Part no.	Name
22-1	Door to circuit breaker cabinet
22-2	Room divider
22-3	Fire extinguisher
22-4	Radio
22-5	Locker
22-6	Bedside table
22-7	Frame (A = toilet roll holder, B = lamp)
22-8	Bulkhead cladding, forward crew quarters
22-9	Toilet door

STAGE 1 → Construction of the cabin area

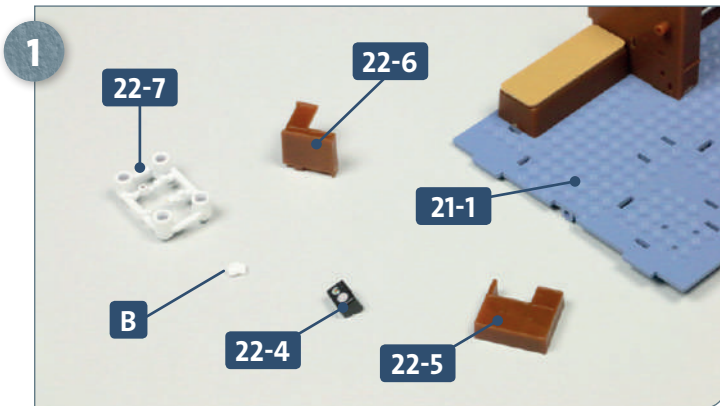

Place the forward crew quarters assembly **21-1** on your work surface. Work starts with the commander's quarters: take the radio **22-4**, lockers **22-5** and bedside table **22-6** and detach the lamp **B** from frame **22-7**.

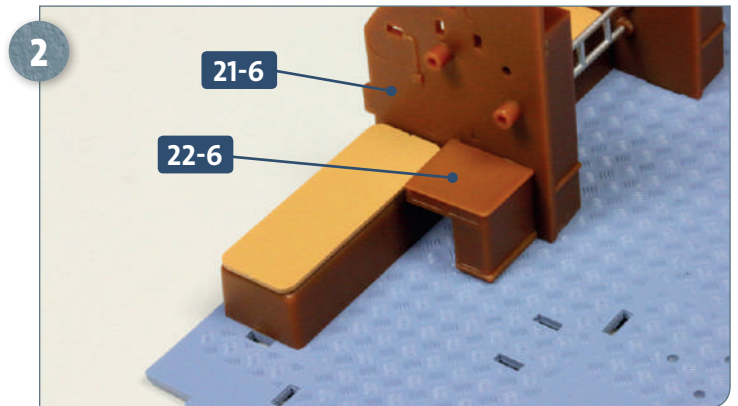

Apply some glue to the tabs on the back of the table **22-6** and insert these into the slots in the room divider **21-6**, as shown.

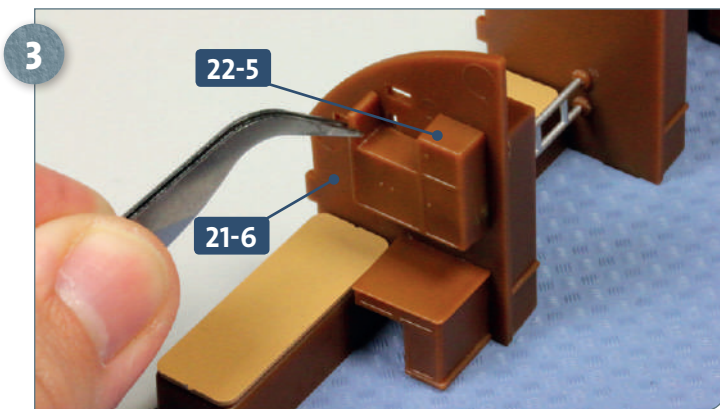

Next, the lockers **22-5** are attached to the room divider **21-6**. Add some glue to the raised sockets on part **21-6** before joining together as shown above.

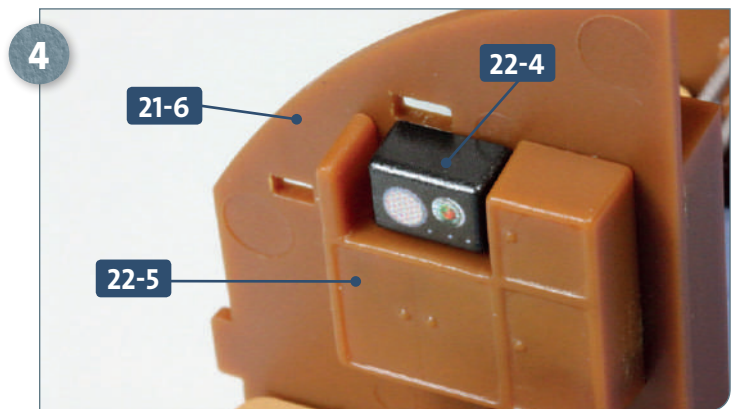

The radio **22-4** fits into the recess at the top of the lockers **22-5**. Apply a little glue to the pegs at the back and insert them into the slots in the room divider **21-6**.

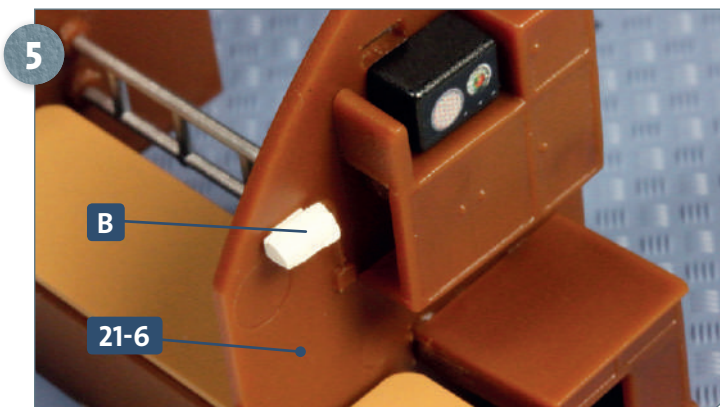

The lamp **B** is glued into the slit to the left of the lockers on the outer edge of the room divider **21-6**, as shown.

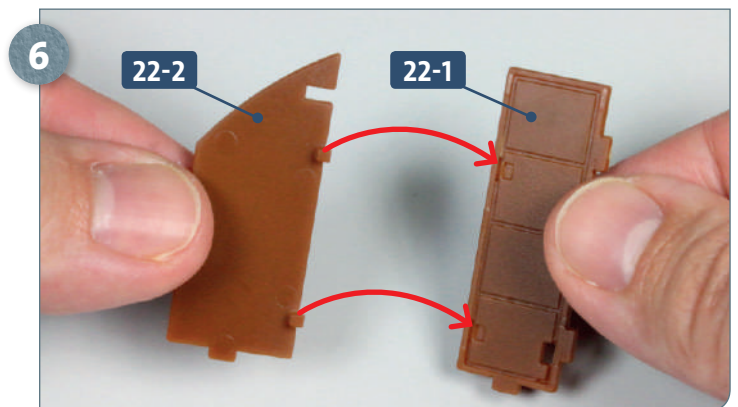

Take the circuit breaker door **22-1** and the room divider **22-2**. Add some glue to the contact points of each part and fit them together at right angles, as indicated by the arrows. See also the next step.

Kit 22: Commander's quarters

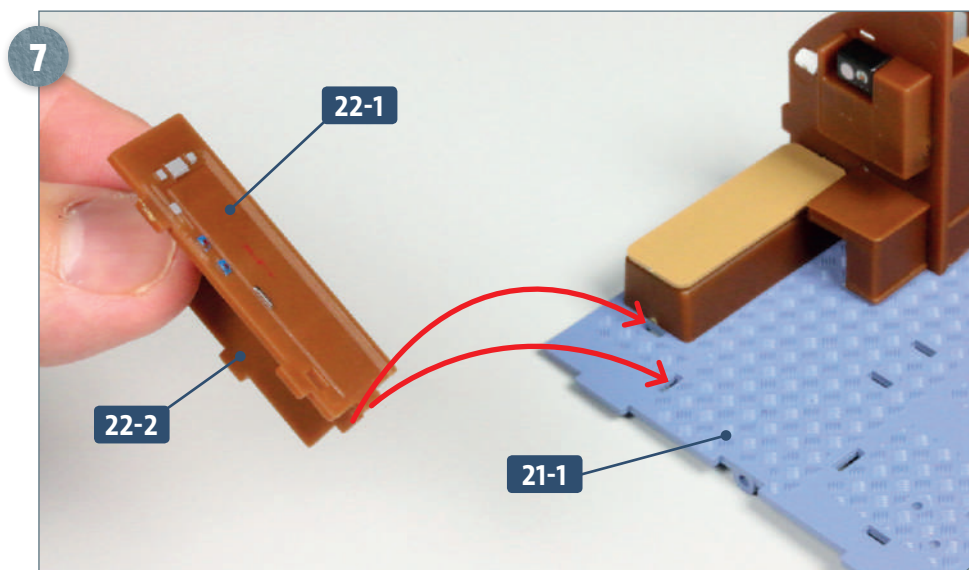

Apply some glue to the pegs at the bottom of the door **22-1** and the room divider **22-2** and fit these into the corresponding slots in the bunk room deck **21-1**, as indicated by the arrows.

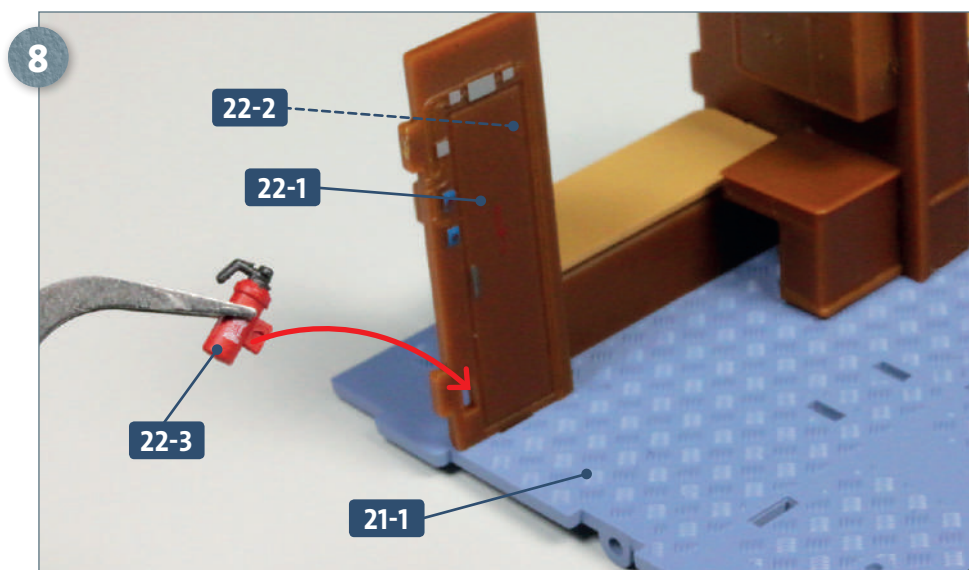

The assembly comprising the door **22-1** and the room divider **22-2** is now attached to the deck **21-1**. Take the fire extinguisher **22-3**, add some glue to the tab on the back, and fit this into the slot at the bottom of the door **22-1**, as indicated by the arrow.

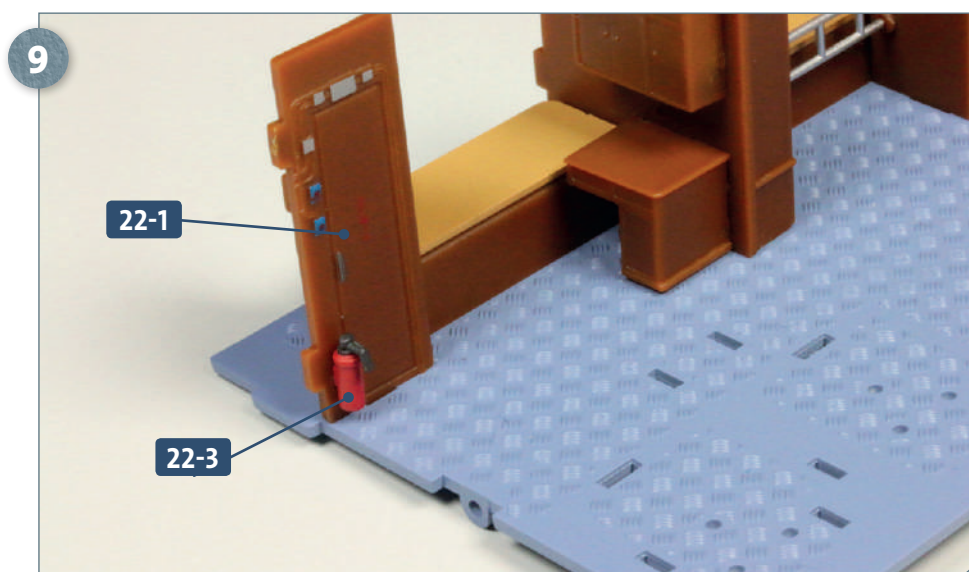

The photo shows the fire extinguisher **22-3** glued in place on the door **22-1**.

Kit 22: Commander's quarters

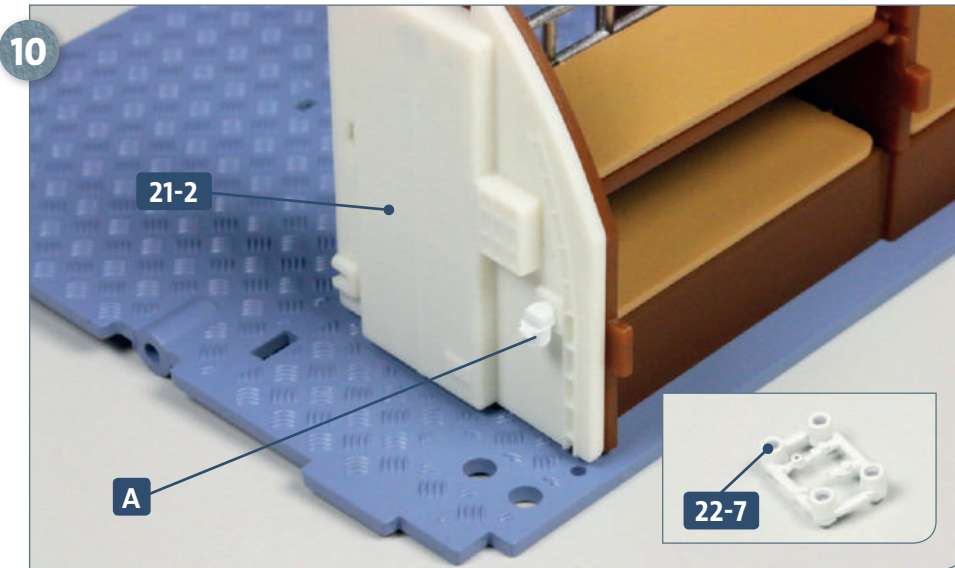

We will now switch to working on the opposite end of the forward crew quarters. Separate the toilet roll holder **A** from frame **22-7**. Apply some glue to the small peg and fit this into the slot in the toilet bulkhead **21-2**.

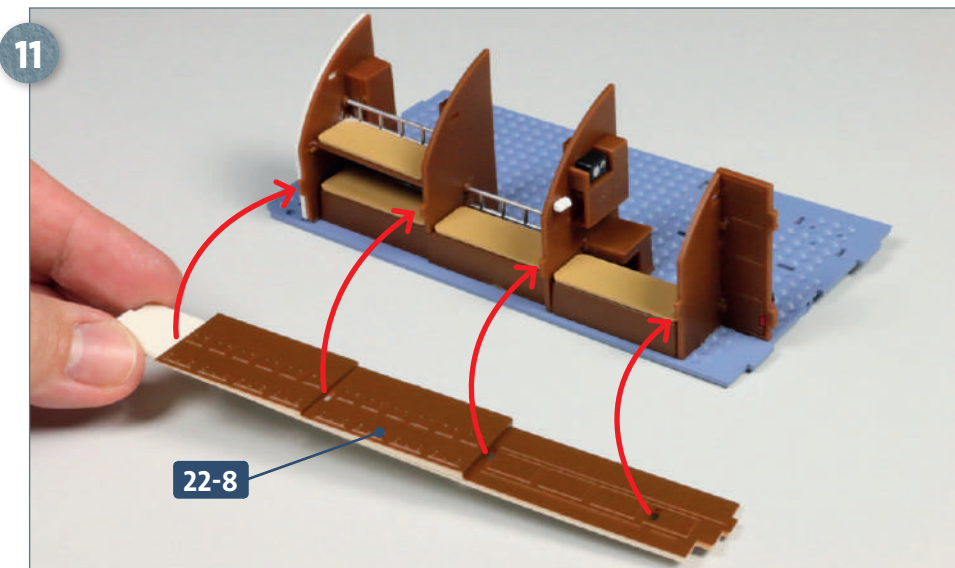

After test-fitting, add some glue to the pegs on the back of each of the four room dividers. Take the bulkhead panelling part **22-8** and fit it onto the room dividers, as indicated by the arrows, left.

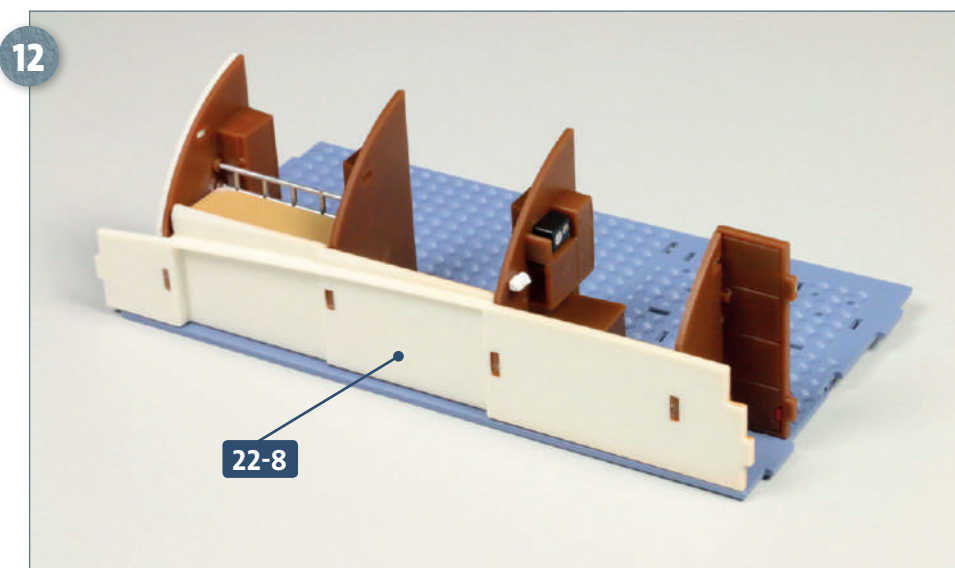

The bulkhead panelling **22-8** is correctly installed when its slots fit fully onto the four tabs of the room dividers, as shown.

Kit 22: Commander's quarters

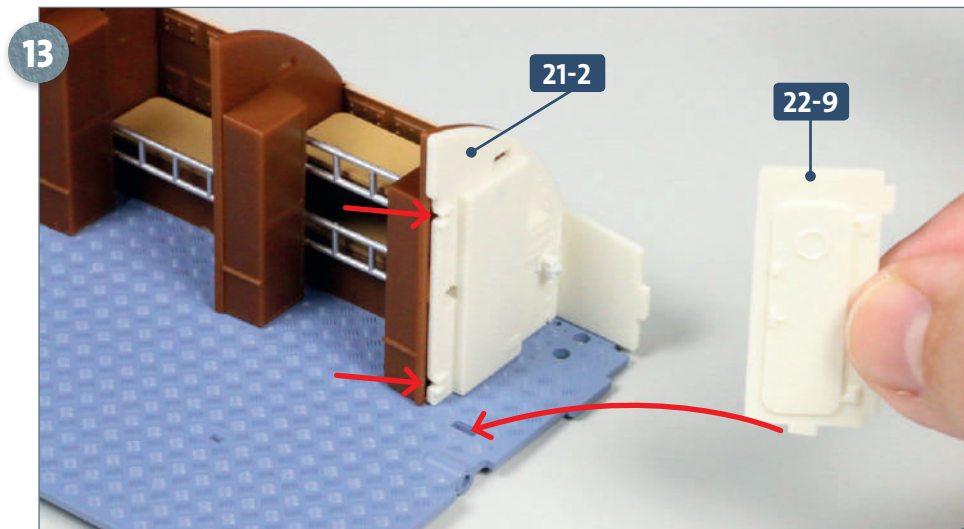

Test-fit the toilet door **22-9** as shown by the arrow and in the next step. If necessary, use side cutters or similar, to remove the lower hinge. Once sure of a good fit, glue in place.

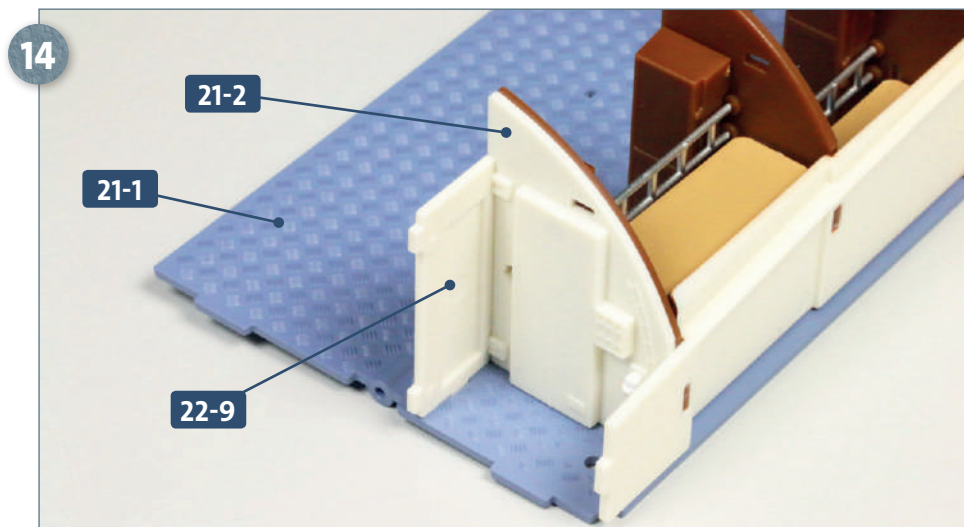

The photo shows the toilet door fitted into the bunk room deck and attached to the toilet bulkhead **21-2**.

COMPLETED WORK

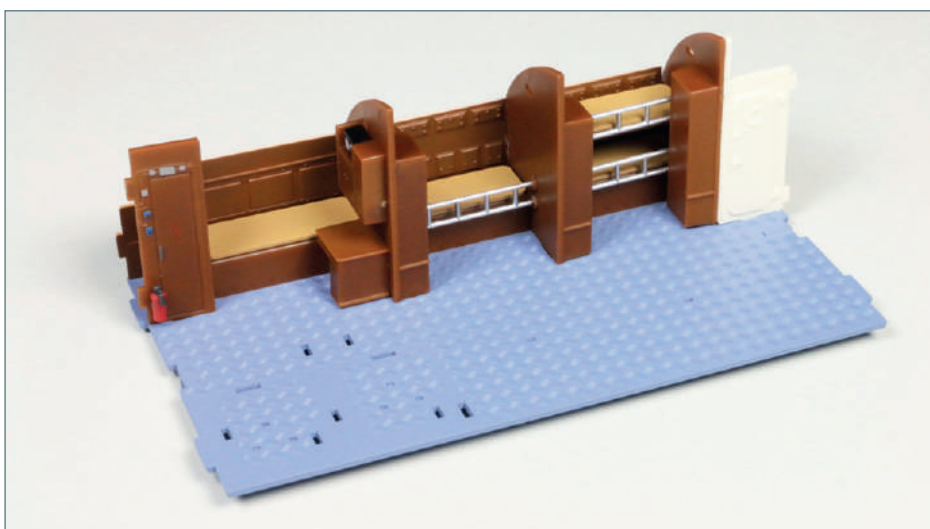

The forward crew quarters assembly has had the commander's bunk fitted out, as well as the toilet.

Kit 23: Radio room & listening room

The furniture and bulkheads for the radio and listening rooms are assembled and installed in the forward crew quarters. The rooms are then fitted with various pieces of equipment.

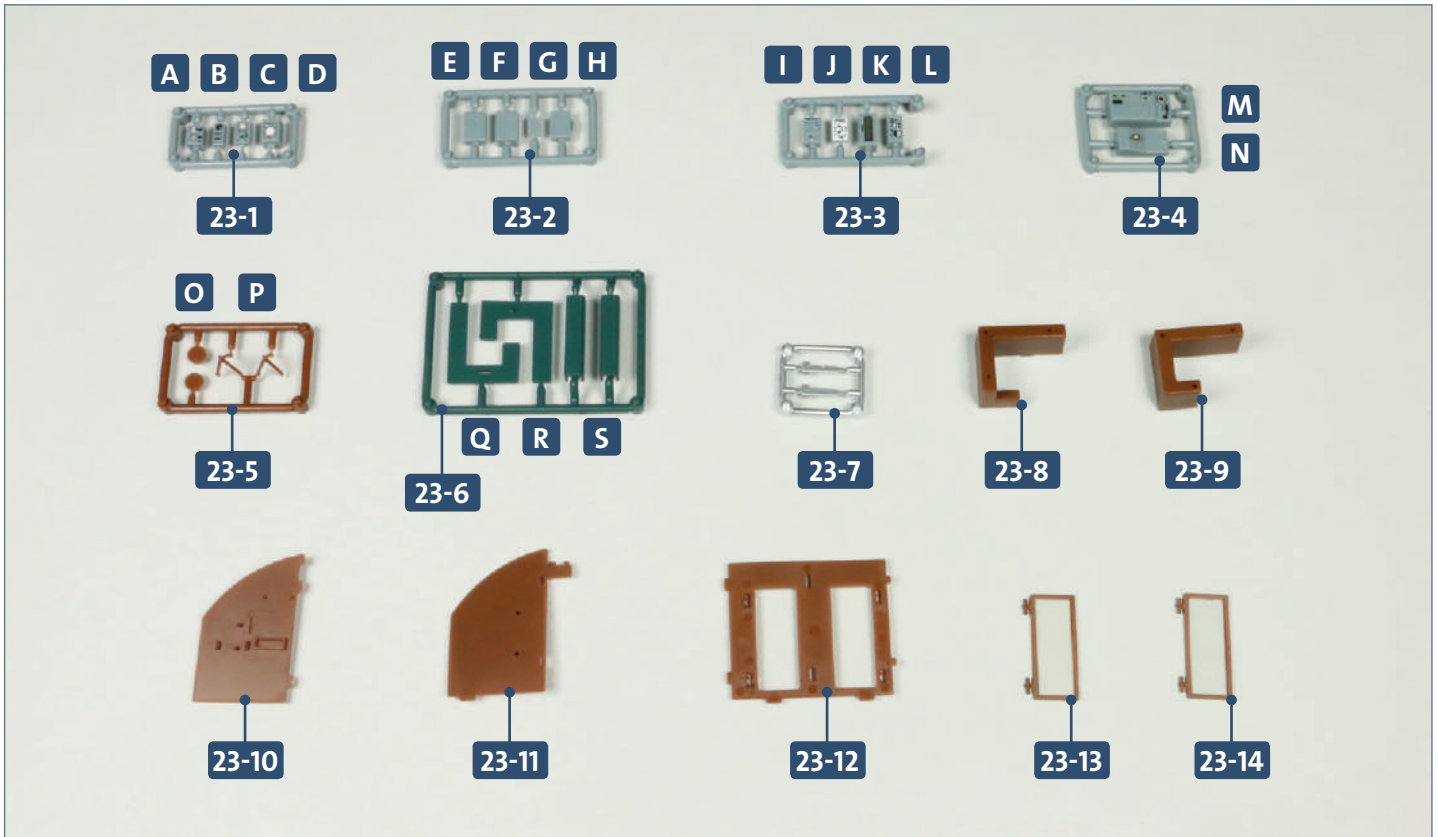

Parts reference list	
Part no.	Name
23-1	Frame with equipment (A, B, C, D)
23-2	Frame with equipment (E, F, G, H)
23-3	Frame with equipment (I, J, K, L)
23-4	Frame with equipment (M, N)
23-5	Frame with stool parts (2 x O, 2 x P)
23-6	Frame with table and bench tops (Q, R, 2 x S)
23-7	Bench legs
23-8	Radio room table
23-9	Listening room table
23-10	Partition bulkhead (radio/listening room)
23-11	Partition bulkhead (listening room)
23-12	Door frame
23-13	Radio room door
23-14	Listening room door

Kit 23: Radio room & listening room

STAGE 1 → Radio and listening room furniture

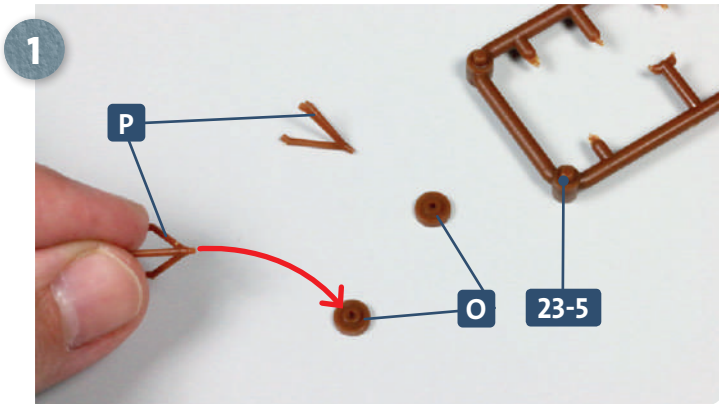

Detach the stool seats **O** and legs **P** from frame **23-5**. Apply some glue to the peg at the apex of one leg piece **P** and insert into the recess in the underside of one of the seats **O**, as shown.

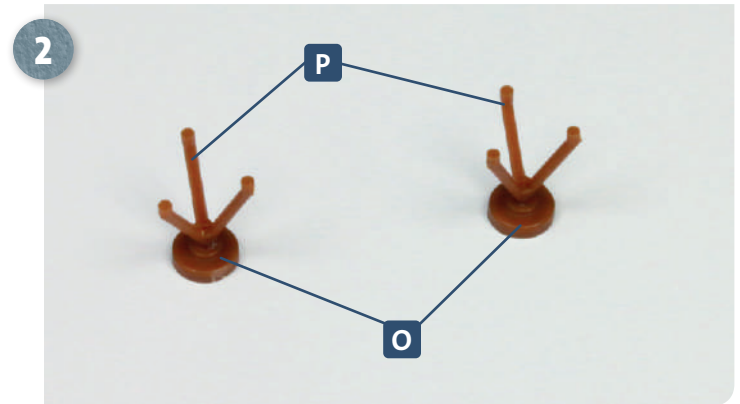

Repeat the process with the second parts **P** and **O**. The photo shows the resulting two identical stools, fully assembled.

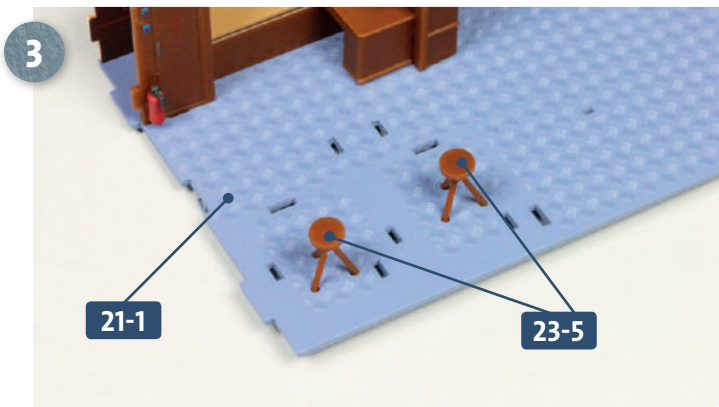

Place the forward bunk room assembly on your work surface. Apply some glue to the bottom of the legs of the two stools **23-5** and fit these into the corresponding holes in the deck **21-1**, as shown in the photo.

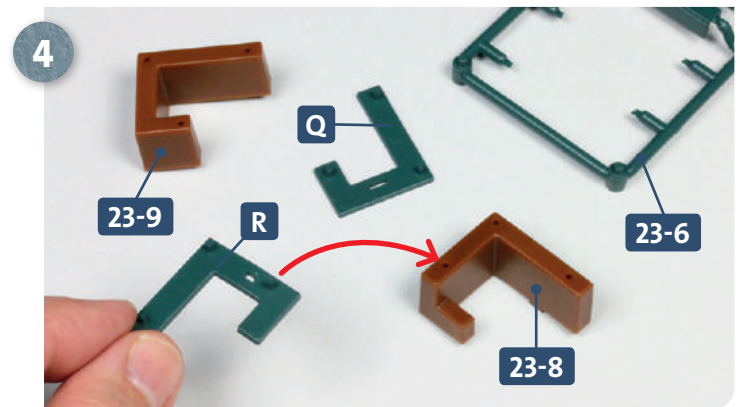

Remove the two tabletops **Q** and **R** from frame **23-6** and locate the two tables, **23-8** and **23-9**. Apply glue to the pegs on the underside of the tabletop **R** and fit it onto the table **23-8**, as shown by the arrow above.

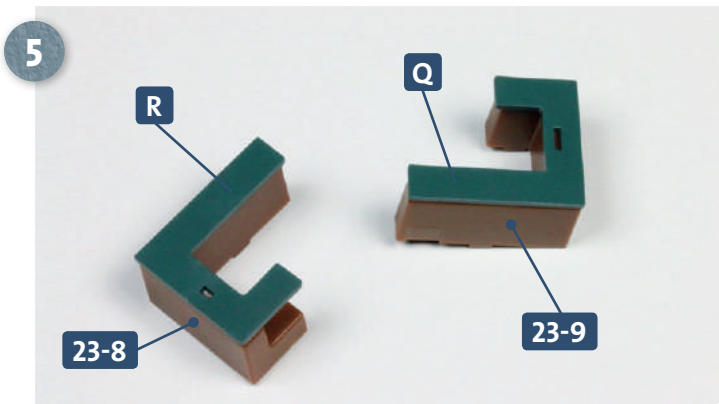

Repeat the process with tabletop **Q** and table **23-9**. The photo shows the two assembled tables.

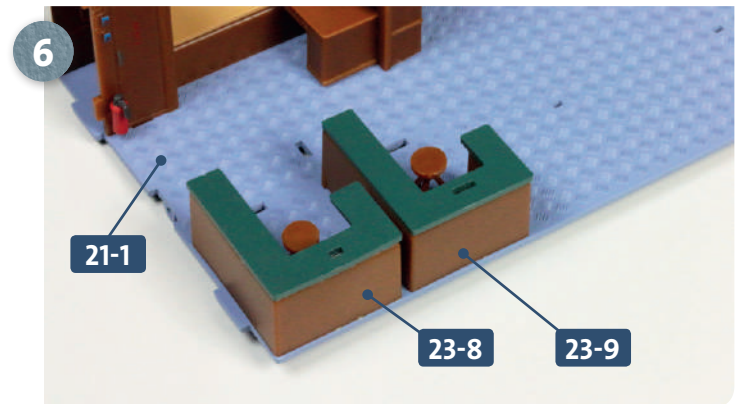

Apply some glue to the pegs on the underside of both tables **23-8** and **23-9** and attach them to the bunk room deck **21-1**, as shown in the photo.

STAGE 2 → The door frame and room partitions

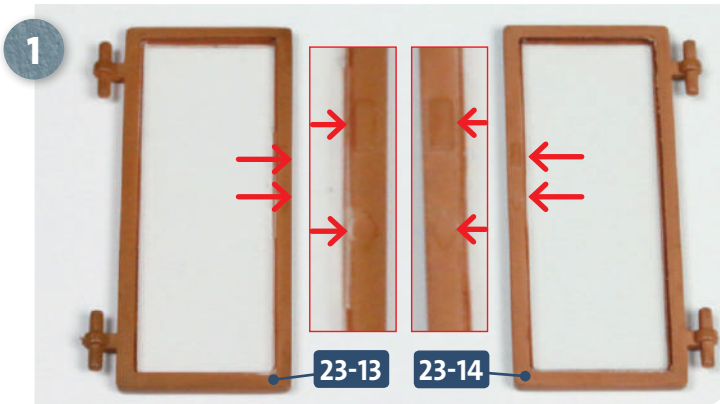

1 Arrange the radio room door **23-13** and listening room door **23-14** as shown above. On both doors, the raised rectangle should be above the diamond shape as shown by the arrows in the inset photo.

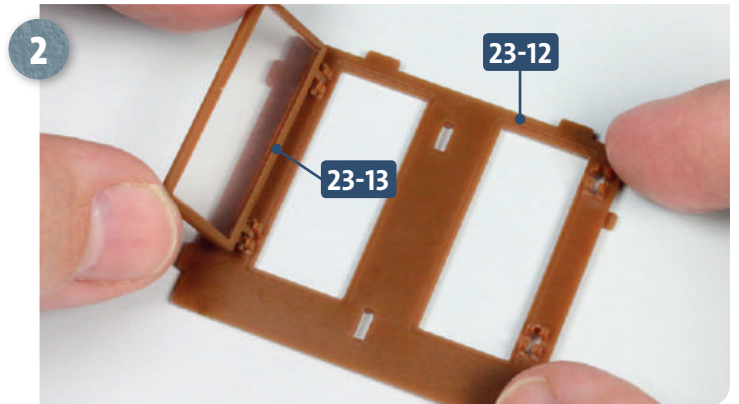

2 Place the door frame **23-12** on your work surface, oriented as shown. Push-fit the radio room door **23-13** into the left hinge of the door frame, as pictured above.

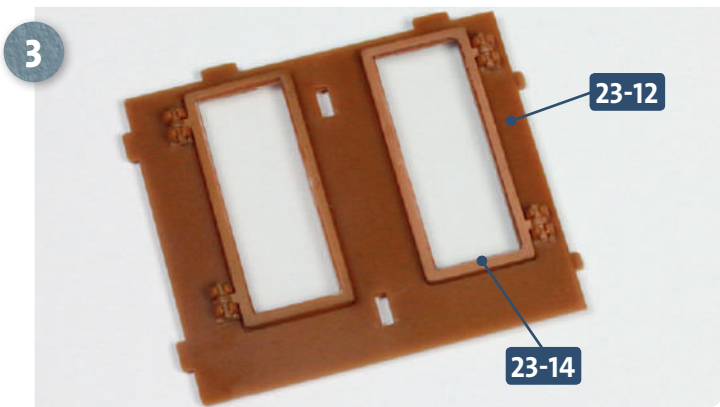

3 The listening room door **23-14** push-fits into the right-hand hinge in the door frame **23-12**, as shown in the photo. Both doors should retain movement.

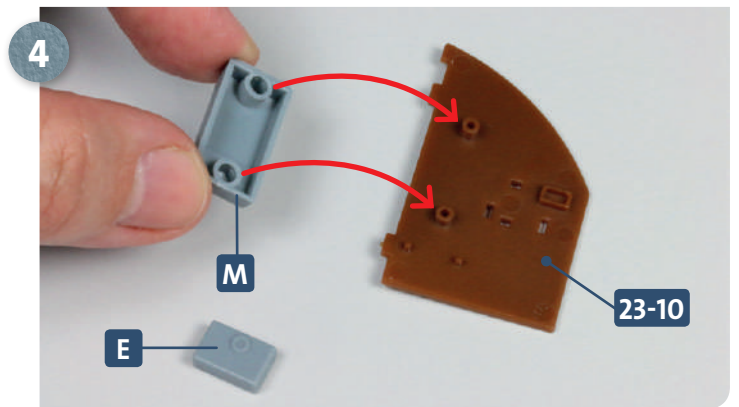

4 Take partition, **23-10**. Remove part **E** from frame **23-2** and part **M** from frame **23-4**. Apply some glue to the back of **M** and fit it onto the large pegs on partition **23-10**, as indicated by the arrows.

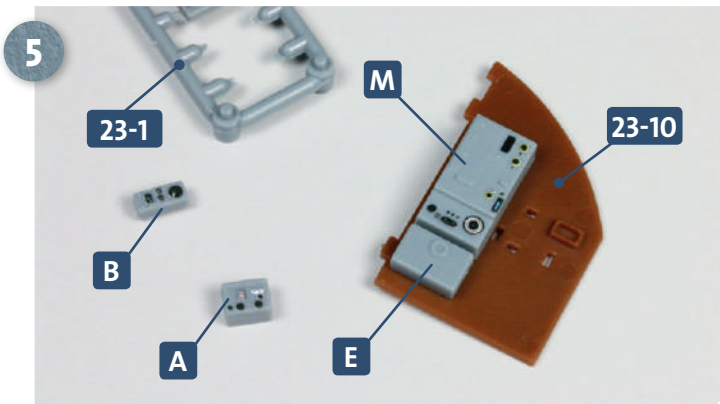

5 Attach part **E** to the partition **23-10** beneath part **M**. Next, remove parts **A** and **B** from frame **23-1**.

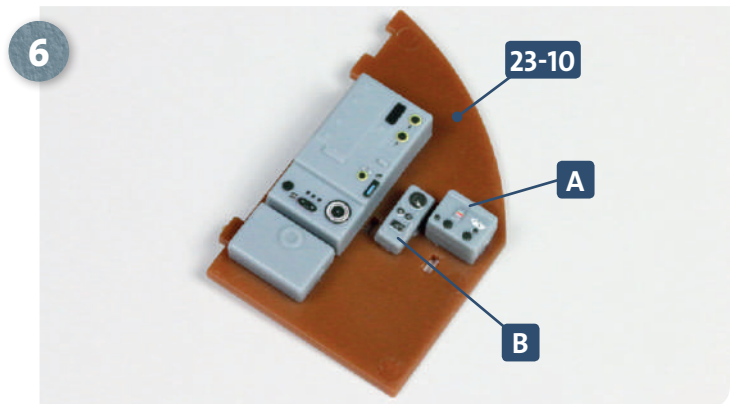

6 Attach parts **A** and **B** to partition **23-10**: apply some glue to the back of the parts and fix in position, as shown.

Kit 23: Radio room & listening room

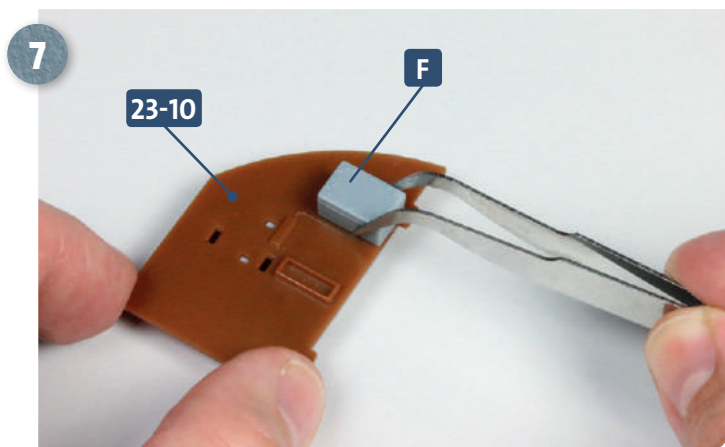

7 Turn the room divider **23-10** over. Separate part **F** from frame **23-2**. Add some glue to the back and attach it to the room divider **23-10**, as shown above.

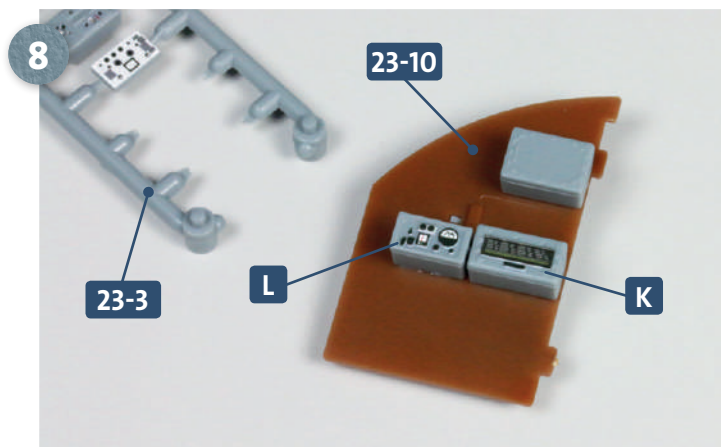

8 Two more parts are glued to the room divider: parts **K** and **L**, from frame **23-3**.

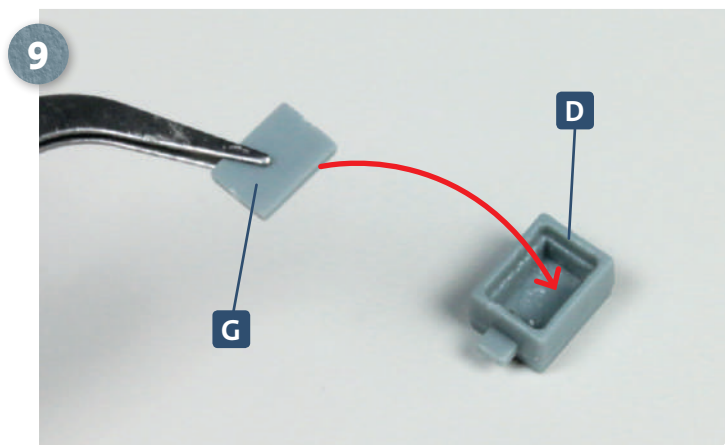

9 Detach part **G** from frame **23-2** and part **D** (including side tab) from frame **23-1**. Glue part **G** into the opening of part **D**, as shown.

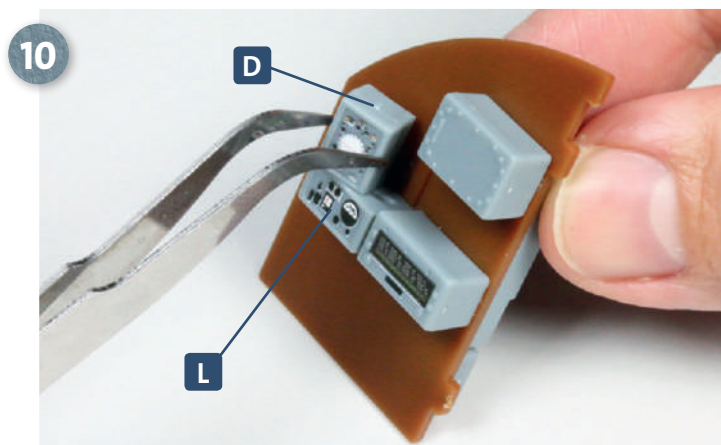

10 Add some glue to the tab at the bottom of part **D** and insert this into the outer angled slot at the top of part **L**, as shown above.

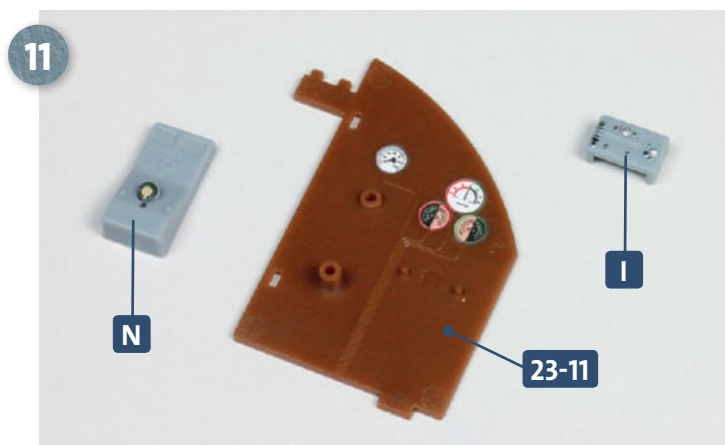

11 Now take partition **23-11** and place it on your work surface as shown above. Take part **I** from **23-3** and part **N** from frame **23-4**.

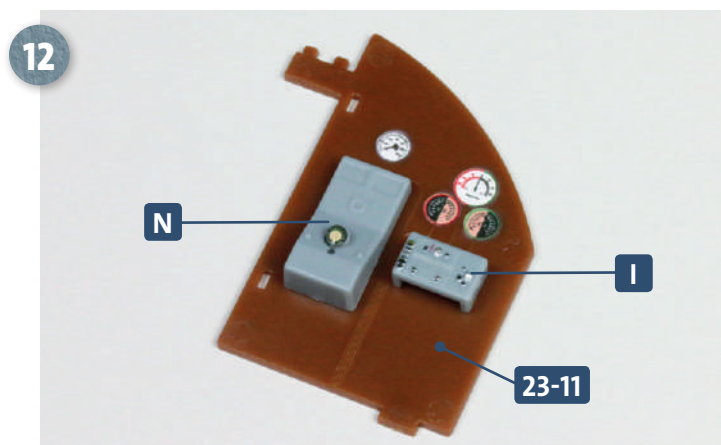

12 Glue parts **I** and **N** to the corresponding pegs on the listening room bulkhead partition **23-11**.

STAGE 3 → Installing the partitions and doors

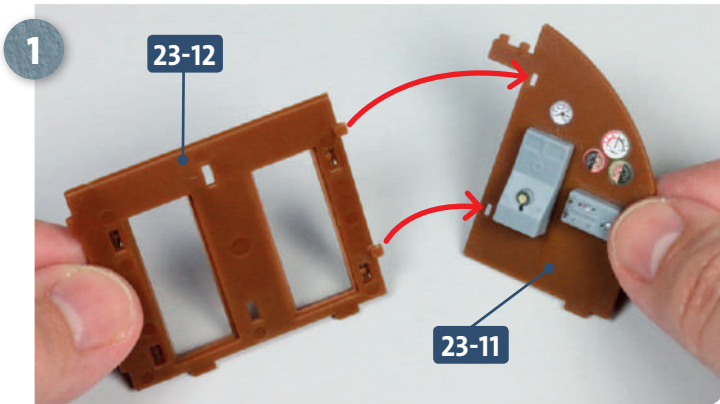

Align the listening room partition **23-11** with the door frame **23-12** as shown. Apply glue sparingly to the contact surfaces of both parts and join together as indicated by the arrows.

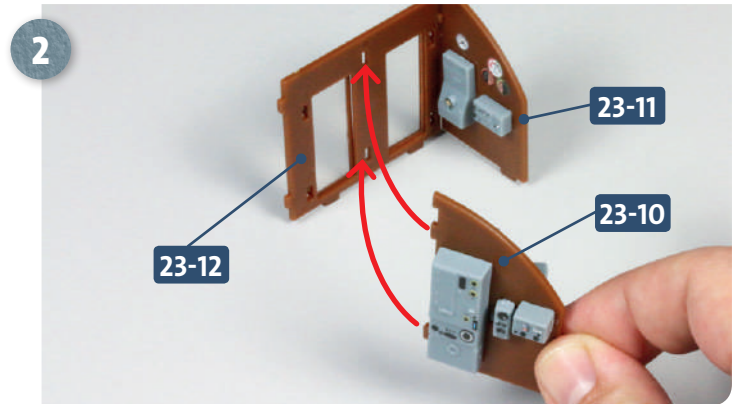

With the listening room partition **23-11** attached to the door frame **23-12**, take partition **23-10**, apply glue sparingly to its contact surfaces, and fit it onto the door frame **23-12**, as shown.

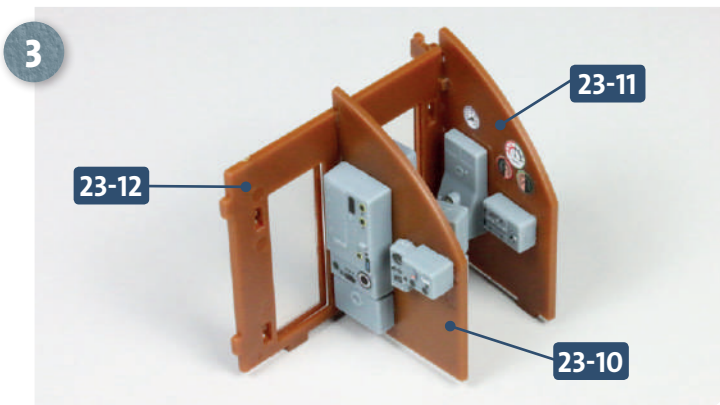

The structure comprising the door frame **23-12** and both partition bulkheads **23-10** and **23-11** for the radio and listening rooms is complete.

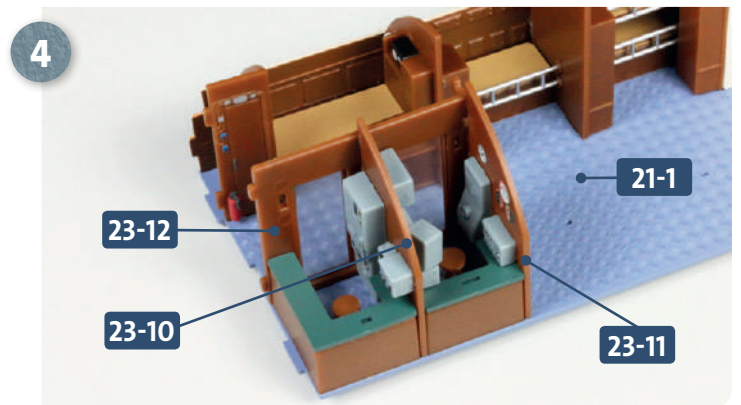

Apply some glue to the bottom edges and the lower pegs of the door frame **23-12**, and partitions **23-10** and **23-11**, and attach the assembly to the deck of the forward crew quarters **21-1**.

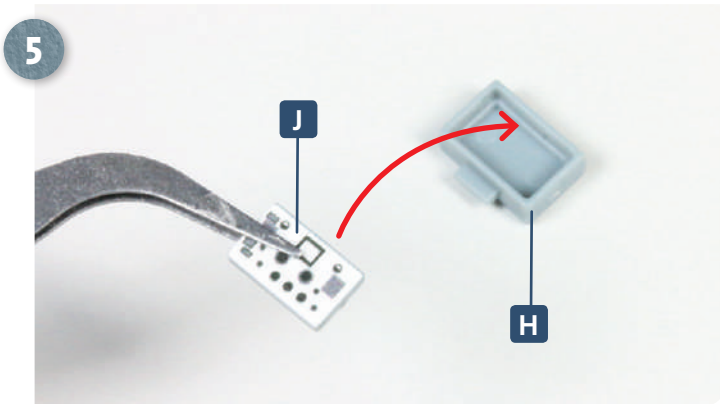

Detach part **H** from frame **23-2** and part **J** from frame **23-3**. Apply some glue to the edges of **J** and fit inside the opening of **H**, as shown in the photo above.

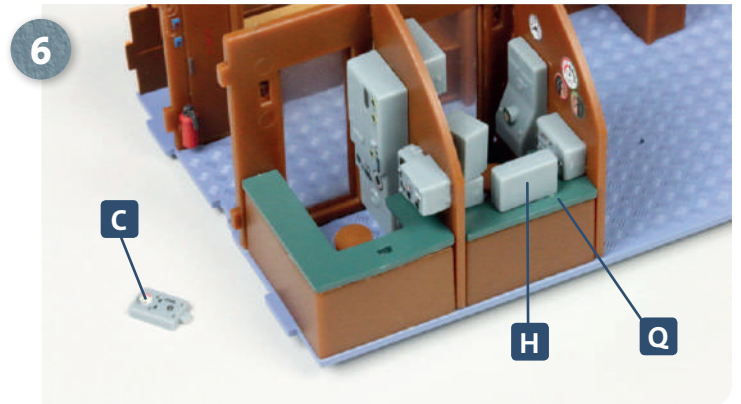

Attach part **H** to the tabletop **Q** in the listening room: apply some glue to the tab at the bottom of **H** and fit it into the slot in the tabletop. Next, remove part **C** from frame **23-1**.

Kit 23: Radio room & listening room

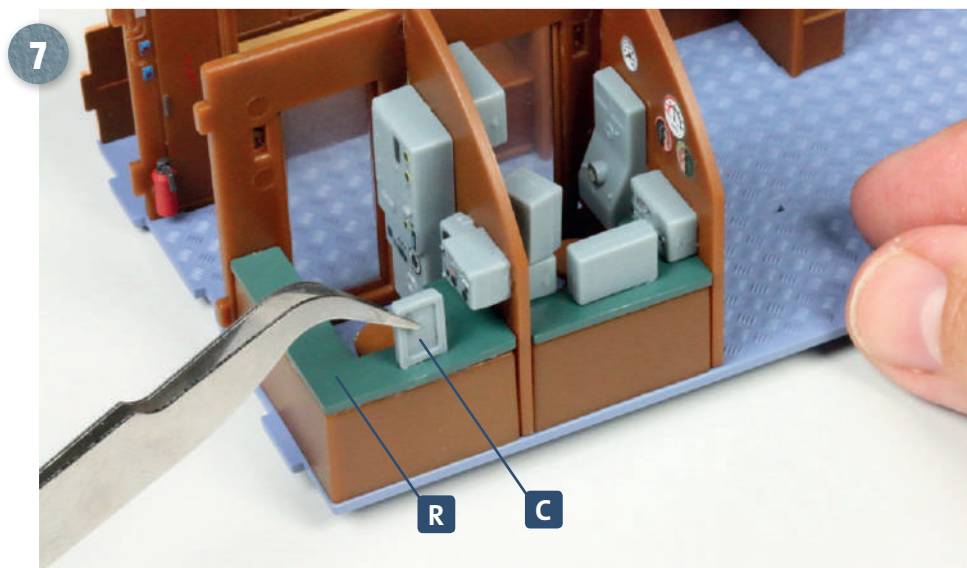

Apply some glue to the peg of **C** and insert this into the slot in the tabletop **R** in the radio room, as shown.

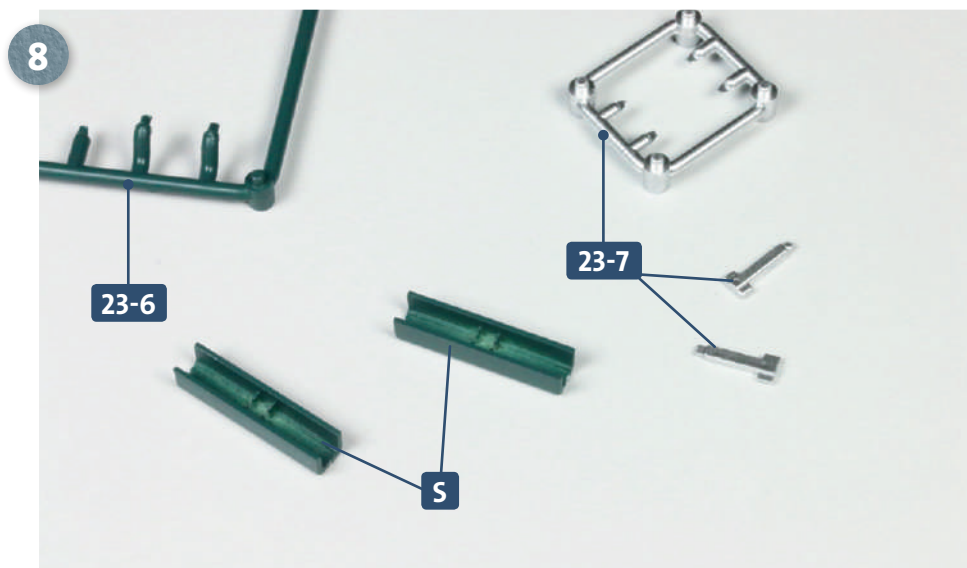

Remove the two bench tops **S** from frame **23-6** and both legs from frame **23-7**. Take care not to accidentally cut off the tabs at the end of the legs.

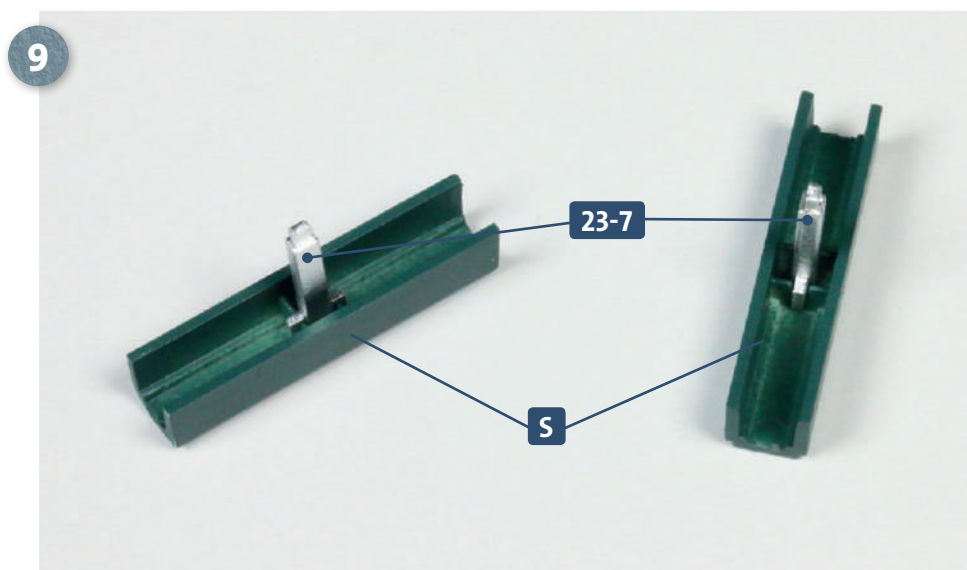

Apply some glue to the top of each of the legs **23-7** and fit these to the underside of each bench seat **S**.

Kit 23: Radio room & listening room

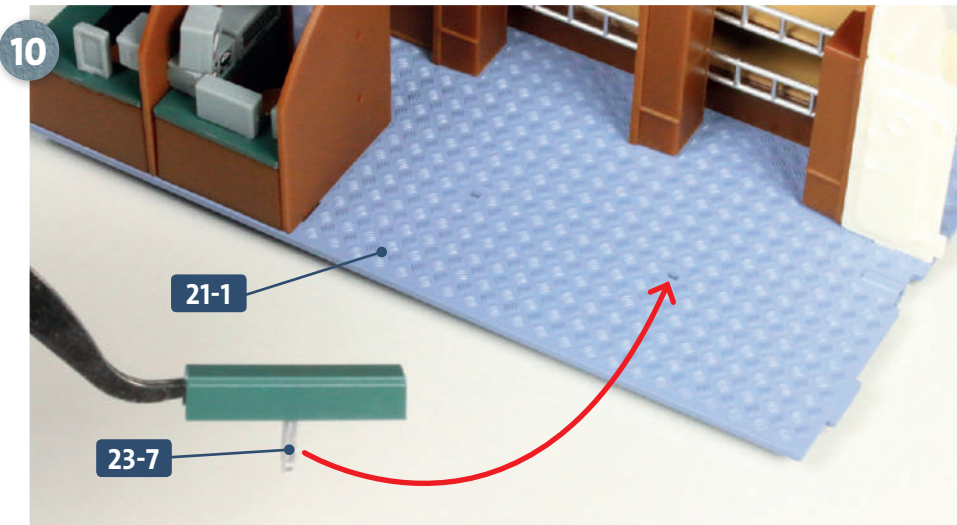

Apply some glue to the bottom of one of the bench legs **23-7** and insert it into the slot in the bunk room deck **21-1**, indicated by the arrow.

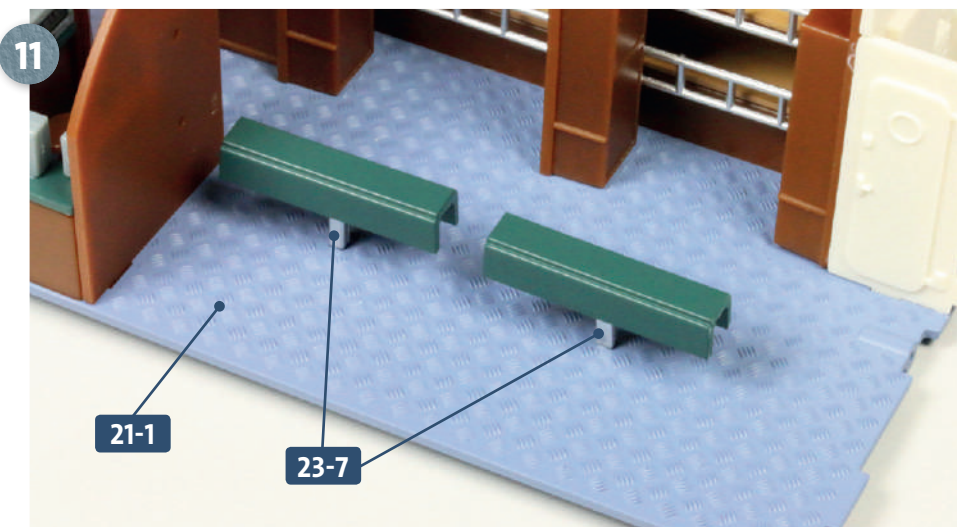

The first bench **23-7** is attached to the deck **21-1**. Repeat the process to glue the leg of the remaining bench **23-7** into the adjacent slot, as shown.

COMPLETED WORK

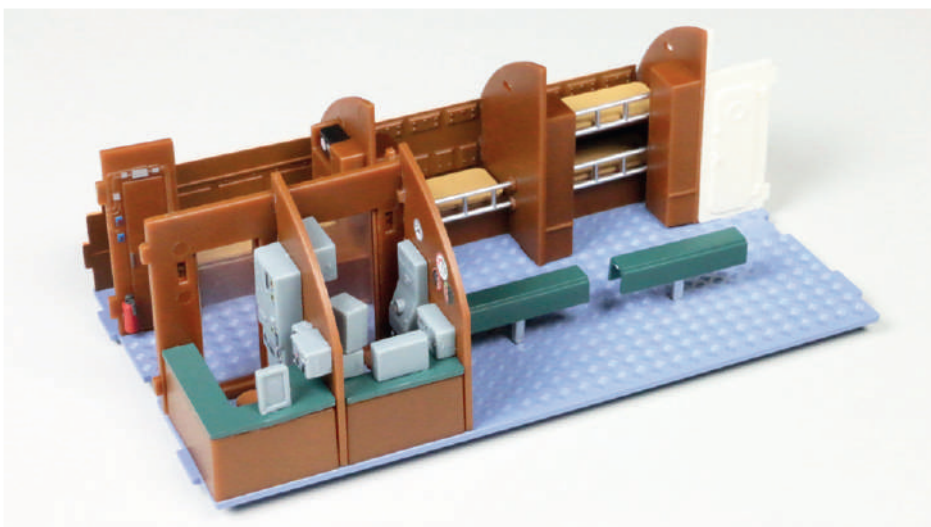

The forward crew quarters assembly has progressed: both the radio and the listening rooms have been assembled, furnished and installed, along with two bench seats.

Kit 24: Forward PCB

The four supplied LED cables are tested, then the forward PCB (Printed Circuit Board) is mounted on the model. The cables from the bow section and the four LED cables are then connected to the circuit board.

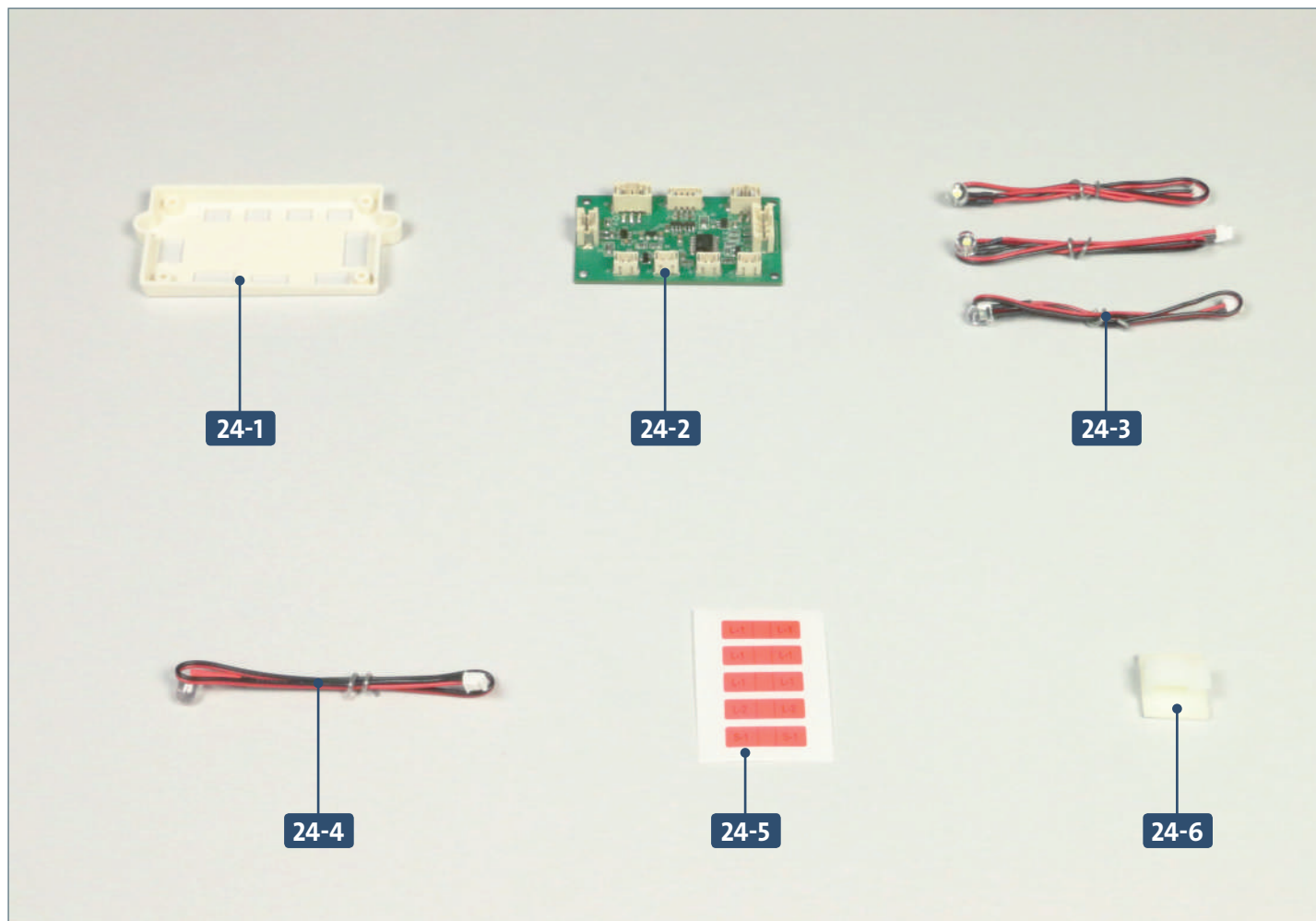

Parts reference list	
Part no.	Name
24-1	PCB cover
24-2	PCB
24-3	3 cables with white LEDs
24-4	Cable with red LED
24-5	Cable labels
24-6	Cable clip

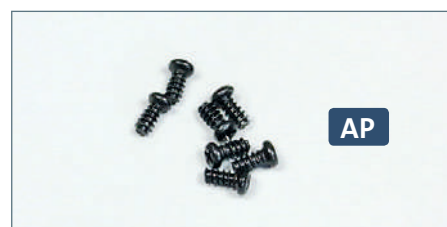

Screws		
Ref	No.	Dimensions
AP	6+1	2 x 4 mm

STAGE 1 → Testing the LEDs

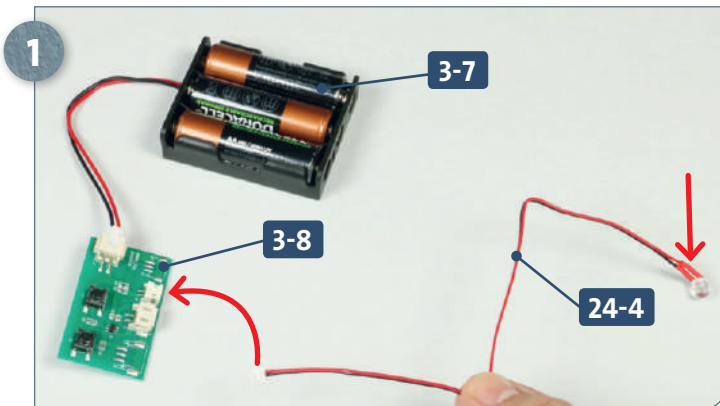

You will need the battery compartment **3-7** with the test PCB **3-8** connected. Take the red LED cable **24-4** (red sleeving as shown by the arrow) and connect it to the small socket on the board.

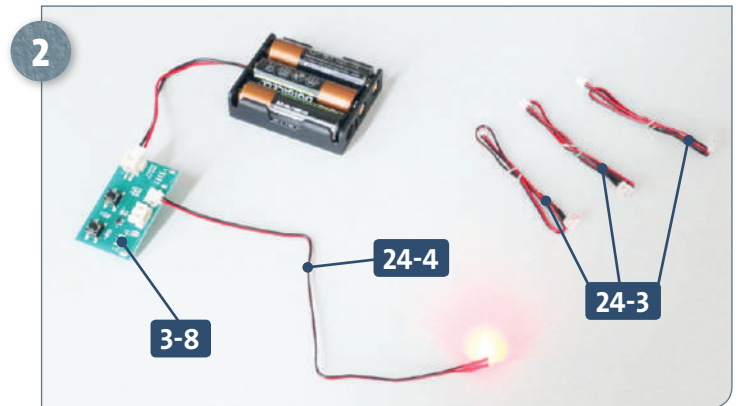

When the cable **24-4** is connected to the socket on the test PCB **3-8**, the red LED should light up. Repeat the test with the three white LED cables **24-3**. Take care when removing the plugs not to pull them by the wires; lever out with tweezers.

STAGE 2 → Assembling the PCB and connecting the cables

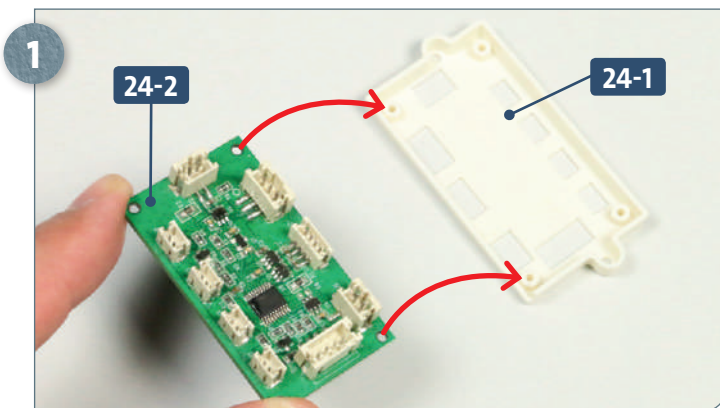

Place the circuit board cover **24-1** on your work surface as shown. Take the PCB **24-2** and fit it into the casing, as indicated by the arrows.

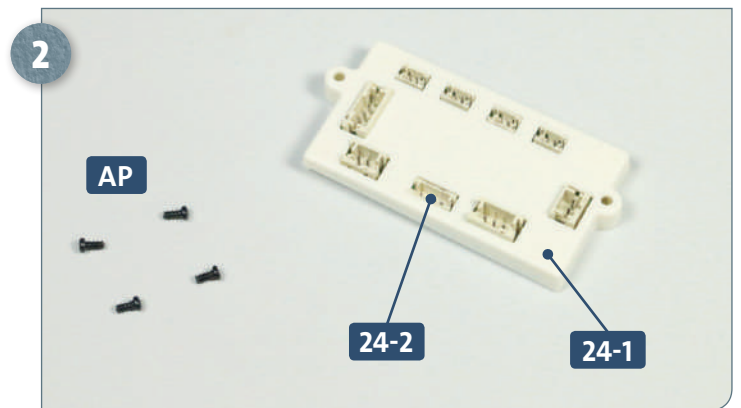

The PCB **24-2** is correctly seated in its cover **24-1** when the sockets are securely fitted within the slots, as shown. Have ready four **AP** screws.

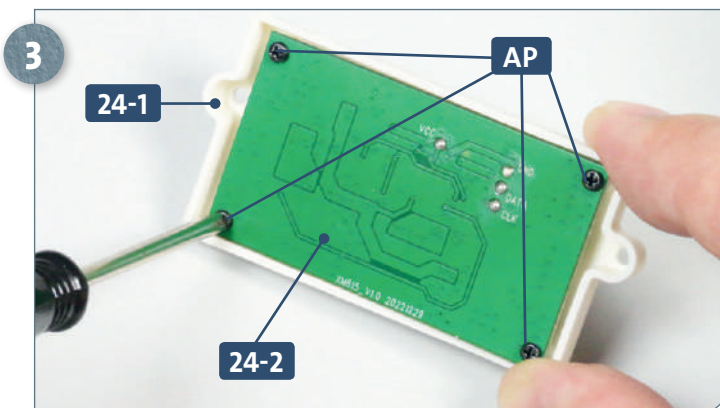

Turn the assembly over and attach the PCB **24-2** to the cover **24-1** using four **AP** screws.

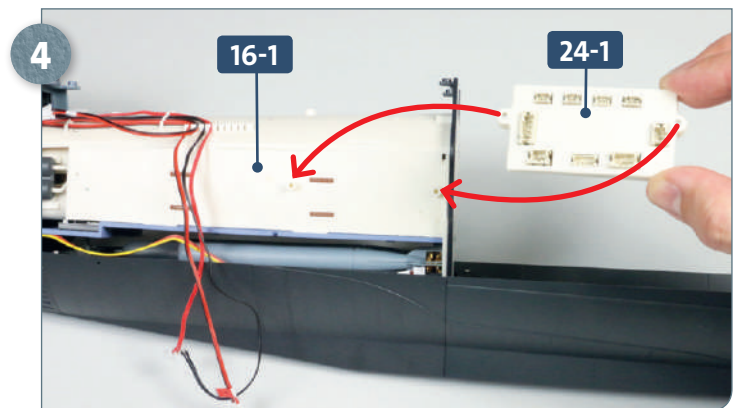

Place the model on your work surface. Offer up the PCB cover **24-1** to the two mounts on the outer side of the bow compartment bulkhead **16-1**.

Kit 24: Forward PCB

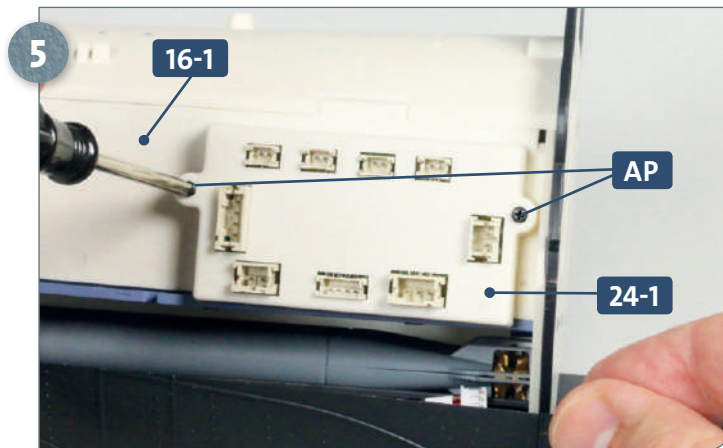

Fix the PCB cover **24-1** in place on the bow compartment bulkhead **16-1** using two **AP** screws. Take care not to over-tighten the screws.

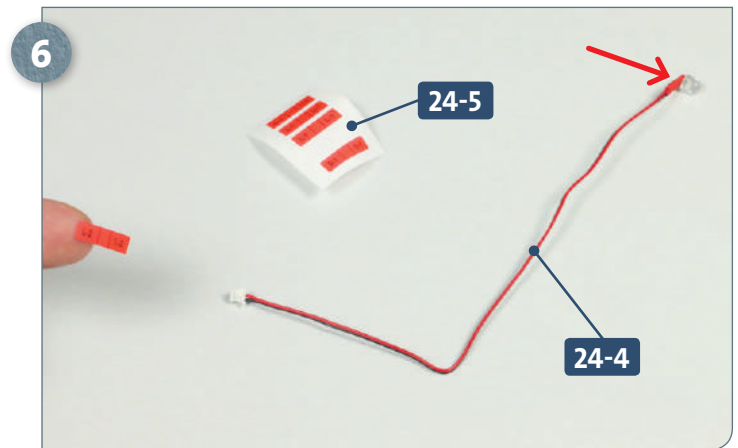

Prepare the cable with the red LED **24-4**. It can be identified by the red sleeving, indicated by the arrow. Peel the cable label **L-2** from its backing sheet **24-5**, as shown.

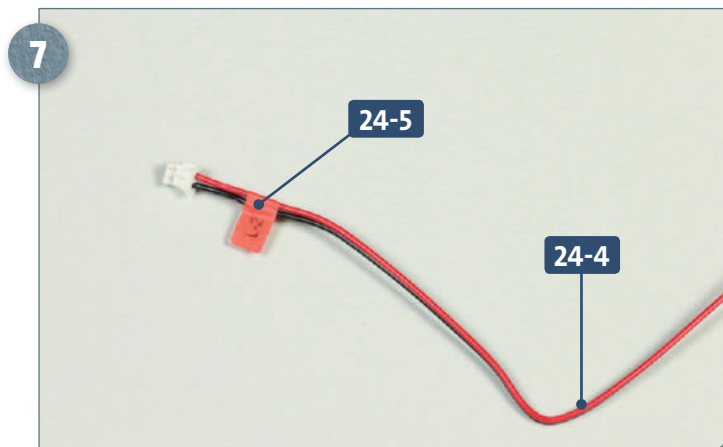

Attach the cable label **24-5 (L-2)** to the cable, approximately 8mm from the connector end of the LED cable **24-4**.

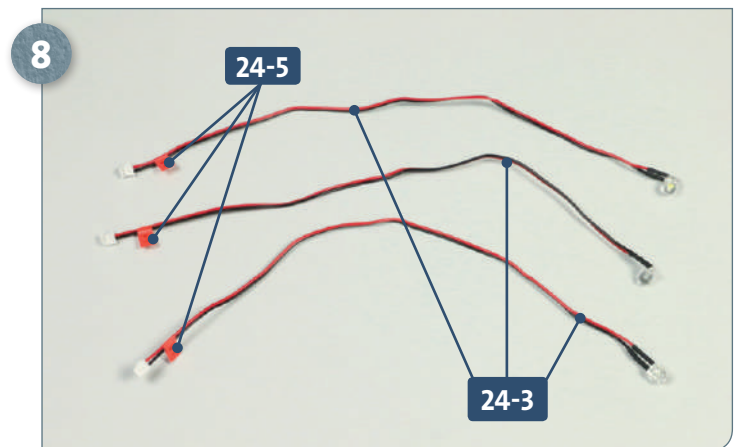

Attach a cable label **24-5 (L-1)** to each of the cables for the white LEDs **24-3** (these have black sleeving). Again, attach the labels approximately 8mm from the connector end of the cables.

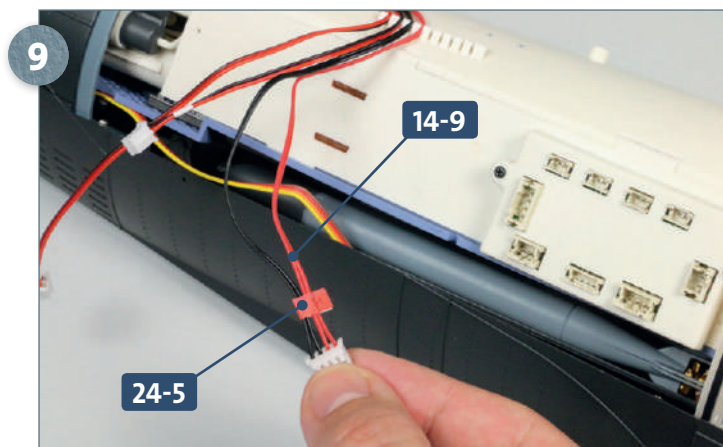

Attach the cable label **24-5 (S-1)** to the cable for the limiting switch **14-9**. Again, attach it approximately 8mm from the terminal.

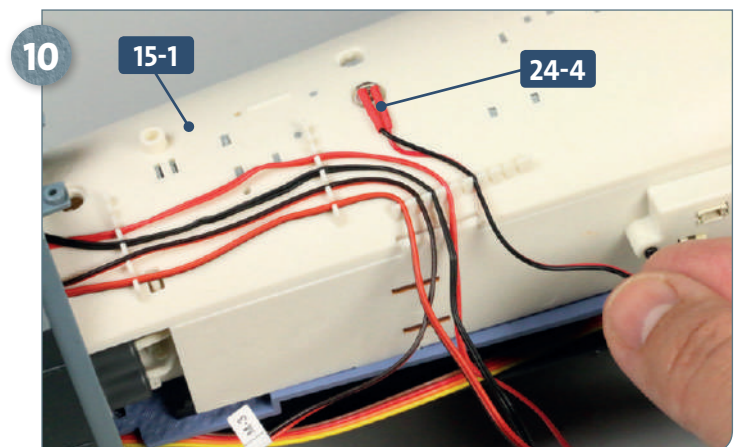

Insert the red LED **24-4** into the hole in the bow compartment deckhead **15-1** as shown. Route the cable through a slot in the cable guide, leaving a gap between it and the cable to the left.

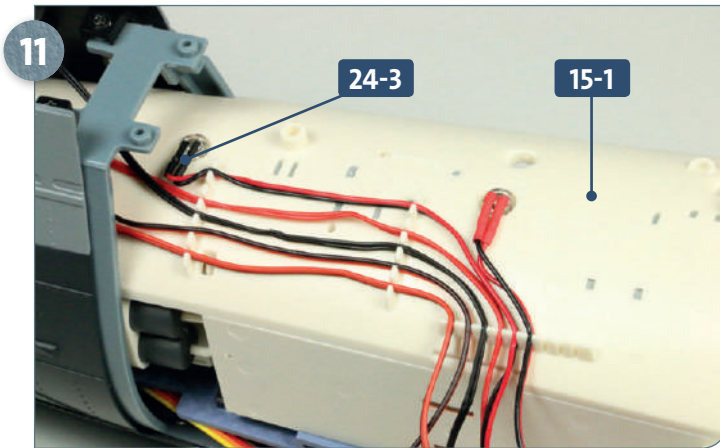

Now take one of the white LED cables **24-3**. Fit the LED in to the forwardmost hole in the bow compartment deckhead **15-1**. Route the cable through all three guides, as shown in the photo above.

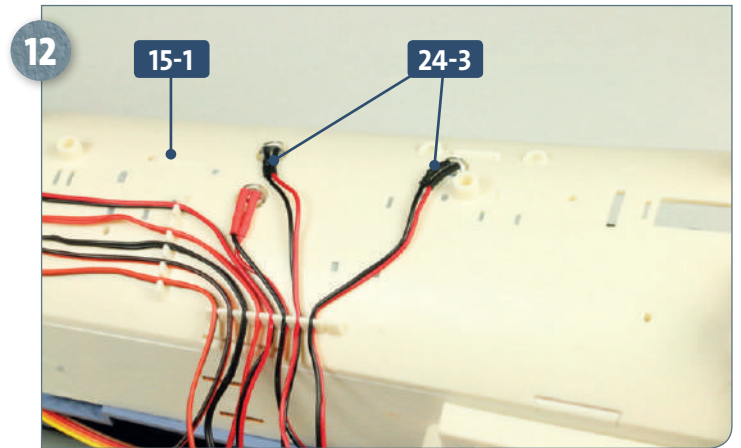

Insert the two other white LEDs **24-3** into the remaining free holes in the bow compartment deckhead **15-1**. Both cables **24-3** are routed through the lateral cable guide only.

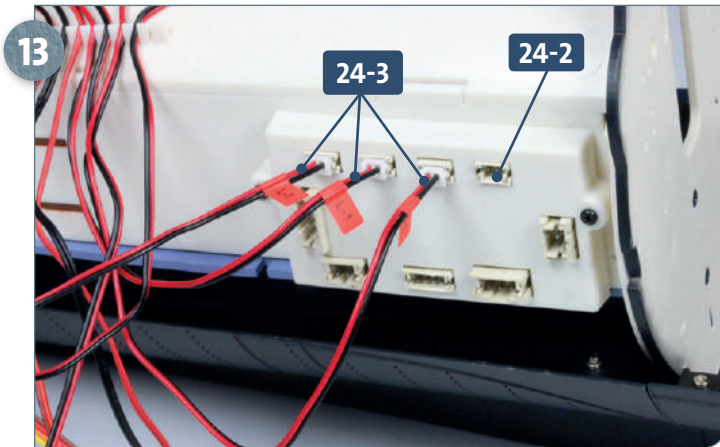

Now the cables are connected to the PCB **24-2**. The three cables **24-3** labelled **L-1** go first, inserted into sockets 1, 2 and 3 on the circuit board. (The order doesn't matter.)

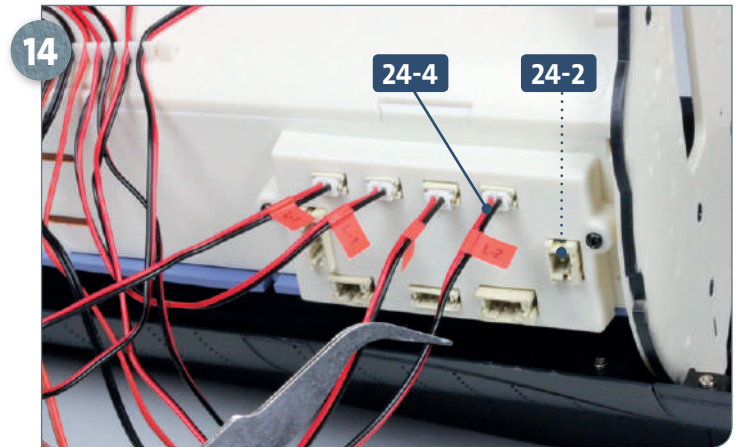

Cable **24-4** labelled **L-2** connects to socket 4 of the PCB **24-2** as shown in the photo.

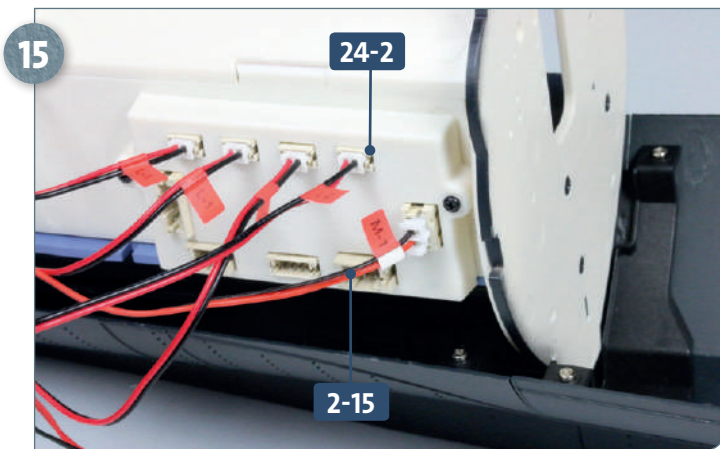

Cable **2-15** labelled **M-1** connects to socket 5 of the PCB **24-2**. **Note:** Socket 6 remains unused for now.

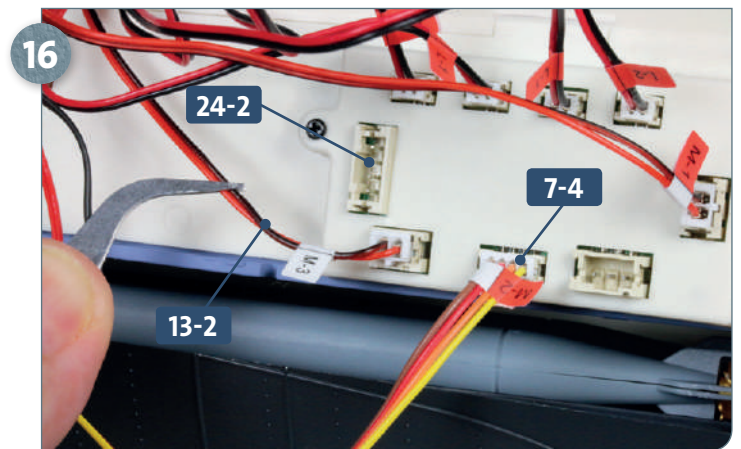

Cable **7-4** labelled **M-2** connects to socket 7 of the PCB **24-2**, and cable **13-2** labelled **M-3** goes into socket 8.

Kit 24: Forward PCB

17

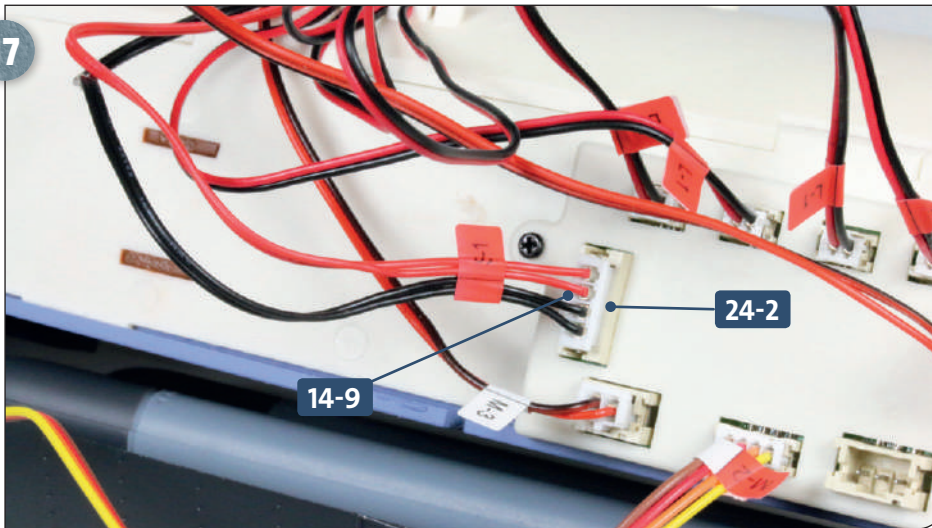

Finally, cable **14-9** labelled **S-1** connects to socket 9 of the PCB **24-2**, as shown.

18

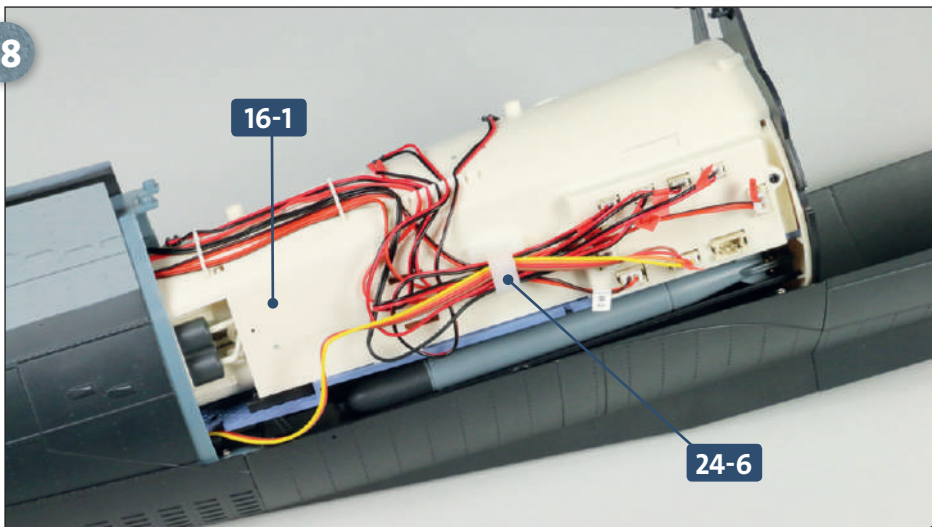

Remove the protective film from the cable clip **24-6** and attach it to the bulkhead of the bow compartment **16-1**. Insert the cables into the clip one at a time so that they are bundled near the circuit board, as shown.

COMPLETED WORK

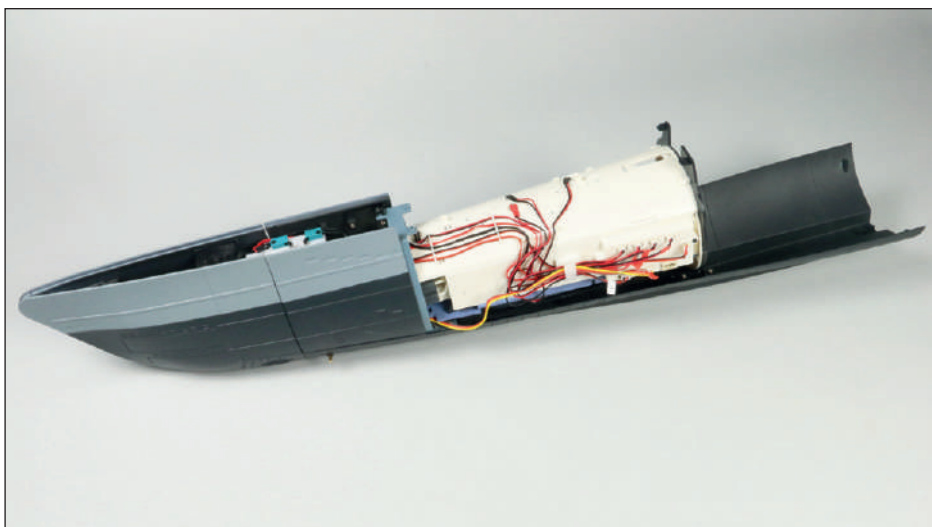

The first PCB has been installed in the model, and the cables from the bow area have been connected to it.